

TaiShan 200 Server

# User Guide (Model 2280)

Issue 06  
Date 2020-04-15



**Copyright © Huawei Technologies Co., Ltd. 2020. All rights reserved.**

No part of this document may be reproduced or transmitted in any form or by any means without prior written consent of Huawei Technologies Co., Ltd.

## **Trademarks and Permissions**



HUAWEI and other Huawei trademarks are trademarks of Huawei Technologies Co., Ltd.

All other trademarks and trade names mentioned in this document are the property of their respective holders.

## **Notice**

The purchased products, services and features are stipulated by the contract made between Huawei and the customer. All or part of the products, services and features described in this document may not be within the purchase scope or the usage scope. Unless otherwise specified in the contract, all statements, information, and recommendations in this document are provided "AS IS" without warranties, guarantees or representations of any kind, either express or implied.

The information in this document is subject to change without notice. Every effort has been made in the preparation of this document to ensure accuracy of the contents, but all statements, information, and recommendations in this document do not constitute a warranty of any kind, express or implied.

## **Huawei Technologies Co., Ltd.**

Address: Huawei Industrial Base  
Bantian, Longgang  
Shenzhen 518129  
People's Republic of China

Website: <https://e.huawei.com>

# About This Document

## Purpose

This document describes the appearance, structure, components, and specifications of the 2280 balanced model (2280 for short) of the TaiShan 200 server, and provides guidance for installing, connecting, powering on, powering off, configuring, installing OS, and troubleshooting the 2280.





## Intended Audience

This document is intended for:

- Huawei technical support engineers
- Technical support engineers from channel partners
- Enterprise administrators

## Symbol Conventions

The symbols that may be found in this document are defined as follows.

Symbol	Description
	Indicates a hazard with a high level of risk which, if not avoided, will result in death or serious injury.
	Indicates a hazard with a medium level of risk which, if not avoided, could result in death or serious injury.
	Indicates a hazard with a low level of risk which, if not avoided, could result in minor or moderate injury.
	Indicates a potentially hazardous situation which, if not avoided, could result in equipment damage, data loss, performance deterioration, or unanticipated results. NOTICE is used to address practices not related to personal injury.

Symbol	Description
☐ NOTE	Supplements the important information in the main text. NOTE is used to address information not related to personal injury, equipment damage, and environment deterioration.

## Change History

Issue	Date	Description
06	2020-04-15	<ul style="list-style-type: none"> <li>Updated the memory specifications of servers with Kunpeng 920 5220 or 3210 processors.</li> <li>Updated the L3 cache capacity of servers with Kunpeng 920 5220 or 3210 processors.</li> </ul>
05	2020-03-03	Modified the description of power consumption.
04	2020-01-16	<ul style="list-style-type: none"> <li>Added information about servers that use Kunpeng 920 5220 or 3210 processors.</li> <li>Added information about the WebUI of iBMC V500 and later versions.</li> </ul>
03	2019-12-17	Added the server with 24 x 2.5" SAS/SATA pass-through drives.
02	2019-11-14	<ul style="list-style-type: none"> <li>Changed the product name.</li> <li>Added the FlexIO card with four 25GE optical ports.</li> </ul>
01	2019-07-01	This issue is the first official release.

---

# Contents

---

<b>About This Document.....</b>	<b>ii</b>
<b>1 Overview.....</b>	<b>1</b>
1.1 Physical Structure.....	1
1.2 Logical Structure.....	3
<b>2 Components.....</b>	<b>7</b>
2.1 Front Panel Components.....	7
2.2 Front Panel Indicators and Buttons.....	10
2.3 Rear Panel Components.....	13
2.4 Rear Panel Indicators.....	15
2.5 FlexIO Cards.....	17
2.6 Drive Slot Numbers and Indicators.....	18
2.6.1 Drive Slot Numbers.....	18
2.6.2 SAS/SATA Drive Indicators.....	21
2.6.3 NVMe SSD Indicators.....	22
2.7 Riser Cards and PCIe Slots.....	23
2.8 Fan Modules.....	29
<b>3 Product Specifications.....</b>	<b>31</b>
3.1 Technical Specifications.....	31
3.2 Environmental Specifications.....	34
3.3 Physical Specifications.....	36
3.4 PSU Specifications.....	37
<b>4 Software and Hardware Compatibility.....</b>	<b>38</b>
<b>5 Install and Configure.....</b>	<b>39</b>
5.1 Tool Preparations.....	39
5.2 Safety Symbols on Devices.....	39
5.3 ESD Protection.....	40
5.3.1 Operation Instructions.....	41
5.3.2 ESD Wrist Strap.....	41
5.4 Environmental Requirements.....	42
5.4.1 Space and Airflow Requirements.....	42
5.4.2 Temperature and Humidity Requirements.....	43

5.4.3 Cabinet Requirements.....	43
5.5 Unpacking the Chassis.....	43
5.6 Installing Optional Parts.....	44
5.7 Installing the Server on Guide Rails.....	44
5.7.1 Installing with L-Shaped Guide Rails.....	44
5.7.2 Installing with Adjustable Guide Rails.....	47
5.8 Connecting External Cables.....	48
5.8.1 Cabling Overview.....	49
5.8.2 Connecting Cables to a Mouse, Keyboard, and VGA Port.....	50
5.8.3 Connecting a Network Cable.....	50
5.8.4 Connecting a Cable to an Optical Port.....	52
5.8.5 Connecting a USB Device.....	55
5.8.6 Connecting a Serial Cable.....	55
5.8.7 Connecting Power Cables.....	56
5.8.7.1 Connecting the AC PSU Cable.....	56
5.8.7.2 Connecting DC PSU Cables.....	57
5.8.8 Verifying Cable Connections.....	58
5.9 Powering On and Off the Server.....	59
5.10 Initial Configuration.....	61
5.10.1 Default Data.....	61
5.10.2 Configuration Process.....	62
5.10.3 Querying the Management Network Port IP Address.....	63
5.10.4 Logging In to the iBMC WebUI.....	66
5.10.5 Checking the Server.....	69
5.10.6 Changing Initial Passwords.....	72
5.10.7 Configuring RAID.....	76
5.10.8 Configuring the BIOS.....	77
5.10.9 Installing an OS.....	84
5.10.10 Upgrading the System.....	85
<b>6 Troubleshooting.....</b>	<b>86</b>
<b>7 Warranty and Safety.....</b>	<b>87</b>
7.1 Maintenance and Warranty.....	87
7.2 Safety.....	87
<b>8 Common Operations.....</b>	<b>88</b>
8.1 Logging In to the Remote Virtual Console.....	88
8.1.1 Logging In to the Remote Virtual Console through the iBMC WebUI.....	88
8.1.2 Logging In to the Server Using the IRC.....	93
8.2 Logging In to the iBMC CLI.....	99
8.3 Logging In to the Server over a Serial Port Using PuTTY.....	102
8.4 Logging In to the Server over a Network Port Using PuTTY.....	104
8.5 Querying the Processor Model of a Server.....	106

<b>9 Support and Other Resources.....</b>	<b>110</b>
9.1 Technical Support.....	110
9.2 Maintenance Tools.....	111
<b>A Appendix.....</b>	<b>112</b>
A.1 BIOS.....	112
A.2 iBMC.....	113
A.3 Glossary.....	114
A.4 Acronyms and Abbreviations.....	116
A.5 Sensor List (Server Configured with the Kunpeng 920 7260, 5250, or 5230 Processor).....	119
A.6 Sensor List (Server Configured with the Kunpeng 920 5220 or 3210 Processor).....	123

# 1 Overview

The TaiShan 200 server powered by HUAWEI Kunpeng 920 processors is dedicated for data centers. Its 2280 balanced model (2280 for short) is a 2U 2-socket rack server. It features high-performance computing, large-capacity storage, low power consumption, easy management, and easy deployment and is ideal for Internet, distributed storage, cloud computing, Big Data, and enterprise services.

**Figure 1-1** shows the appearance of a server with 12 drives.

**Figure 1-1** Appearance



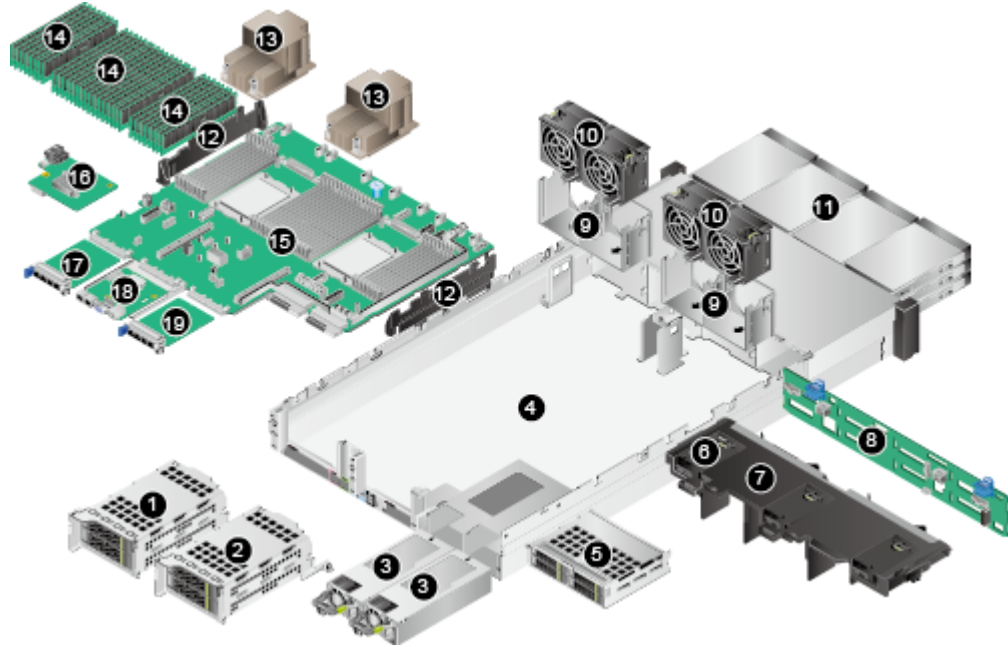
## 1.1 Physical Structure

The physical structure of the 2280 varies depending on the CPU configuration and drive configuration. This section uses the server with 12 drives as an example to describe the physical structure of servers with different processors.



When configured with Kunpeng 920 7260, 5250, or 5230 processors, the server provides 32 DIMM slots. **Figure 1-2** shows the components of the server.

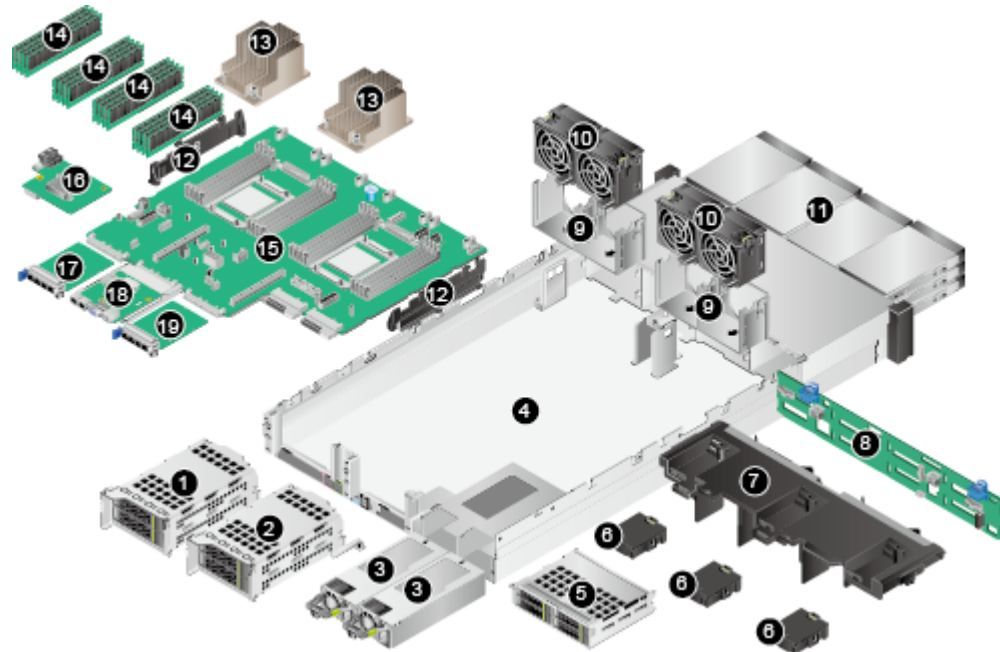
**Figure 1-2** Components (server with Kunpeng 920 7260, 5250, or 5230 processors)



- |    |                       |    |                        |
|----|-----------------------|----|------------------------|
| 1  | I/O module 1          | 2  | I/O module 2           |
| 3  | PSUs                  | 4  | Chassis                |
| 5  | I/O module 3          | 6  | Supercapacitor bracket |
| 7  | Air duct              | 8  | Front drive backplane  |
| 9  | Fan module brackets   | 10 | Fan modules            |
| 11 | Front drives          | 12 | Cable organizers       |
| 13 | Heat sinks            | 14 | DIMM                   |
| 15 | Mainboard             | 16 | RAID controller card   |
| 17 | FlexIO card 1 (CPU 1) | 18 | iBMC card              |
| 19 | FlexIO card 2 (CPU 2) | -  | -                      |

When configured with Kunpeng 920 5220 or 3210 processors, the server provides 16 DIMM slots. **Figure 1-3** shows the components of the server.

**Figure 1-3** Components (server with Kunpeng 920 5220 or 3210 processors)



- |    |                       |    |                        |
|----|-----------------------|----|------------------------|
| 1  | I/O module 1          | 2  | I/O module 2           |
| 3  | PSUs                  | 4  | Chassis                |
| 5  | I/O module 3          | 6  | Supercapacitor bracket |
| 7  | Air duct              | 8  | Front drive backplane  |
| 9  | Fan module brackets   | 10 | Fan modules            |
| 11 | Front drives          | 12 | Cable organizers       |
| 13 | Heat sinks            | 14 | DIMM                   |
| 15 | Mainboard             | 16 | RAID controller card   |
| 17 | FlexIO card 1 (CPU 1) | 18 | iBMC card              |
| 19 | FlexIO card 2 (CPU 2) | -  | -                      |

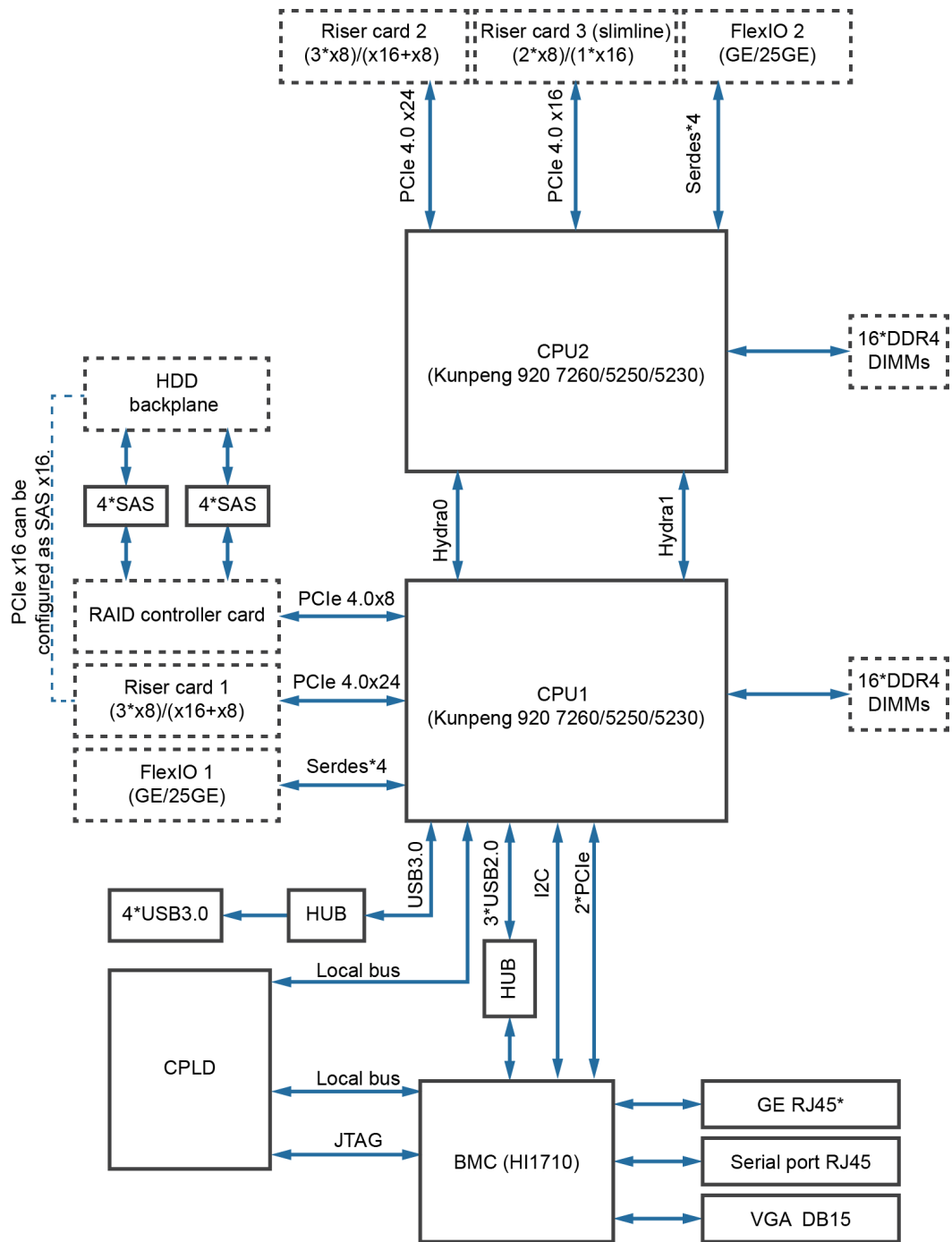
#### NOTE

- For details about how to query the CPU model, see [8.5 Querying the Processor Model of a Server](#).
- I/O modules 1, 2, and 3 can be drive modules or riser modules. The preceding figure is for reference only.
- CPUs are integrated on the mainboard and cannot be replaced independently.
- Use the [Intelligent Computing Spare Parts Checker](#) to obtain information about the spare parts.

## 1.2 Logical Structure

**Figure 1-4** shows the logical structure of the 2280 server using a Kunpeng 920 7260, 5250, or 5230 processor.

**Figure 1-4** Logical structure of the 2280 server (Kunpeng 920 7260, 5250, or 5230 processor)

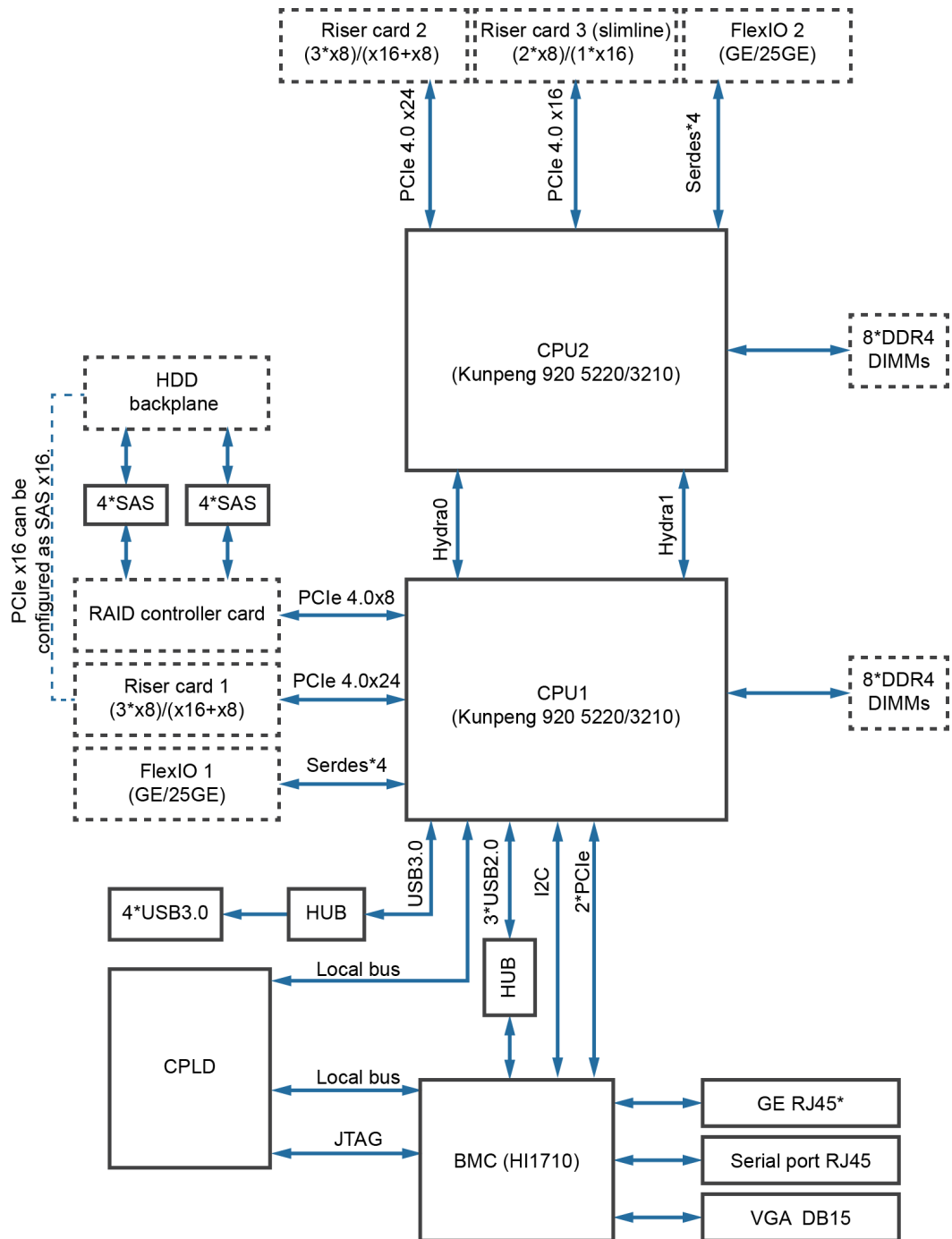


- The server supports two Huawei-developed Kunpeng 920 7260, 5250, or 5230 processors, each of which supports 16 DDR4 DIMMs.
- CPU1 and CPU2 are interconnected through two Hydra buses. The maximum transmission rate of a single bus is 30 Gbit/s.
- The server can come with an Ethernet FlexIO card with four GE or 25GE ports, which are connected to the CPUs through the high-speed SerDes interface.

- The screw-in RAID controller card connects to CPU 1 through PCIe buses, and to the drive backplanes through SAS signal cables. The server supports flexible drive configurations, depending on the drive backplanes used.
- The iBMC uses the Huawei Hi1710 and provides a VGA port, management network port, and debugging serial port.

Figure 1-5 shows the logical structure of the 2280 server using a Kunpeng 920 5220 or 3210 processor.

Figure 1-5 Logical structure of the server (Kunpeng 920 5220 or 3210 processor)



- The server supports two Huawei-developed Kunpeng 920 5220 or 3210 processors, each of which supports 8 DDR4 DIMMs.
- CPU1 and CPU2 are interconnected through a Hydra bus, whose maximum transmission rate is 30 Gbit/s.
- The server can come with an Ethernet FlexIO card with four GE or 25GE ports, which are connected to the CPUs through the high-speed SerDes interface.
- The screw-in RAID controller card connects to CPU 1 through PCIe buses, and to the drive backplanes through SAS signal cables. The server supports flexible drive configurations, depending on the drive backplanes used.
- The iBMC uses the Huawei Hi1710 and provides a VGA port, management network port, and debugging serial port.

# 2 Components

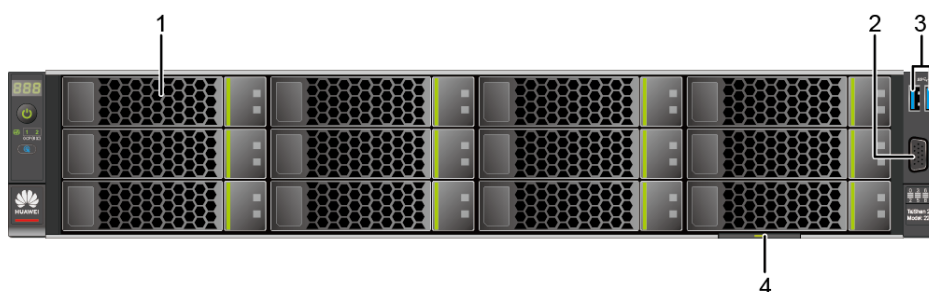
## 2.1 Front Panel Components

### NOTE

For details about the drive numbers and types of 2280, see [2.6.1 Drive Slot Numbers](#).

- **Figure 2-1** shows the components on the front panel of a server with 12 x 3.5-inch drives.

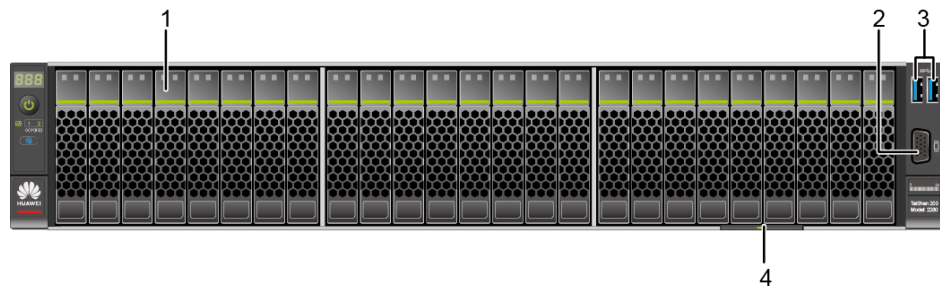
**Figure 2-1** Components on the front panel of a server with 12 x 3.5-inch drives



- |                |                                |
|----------------|--------------------------------|
| 1 Drive        | 2 VGA port                     |
| 3 USB 3.0 port | 4 Label plate with an SN label |

- **Figure 2-2** shows the components on the front panel of a server with 25 x 2.5-inch drives.

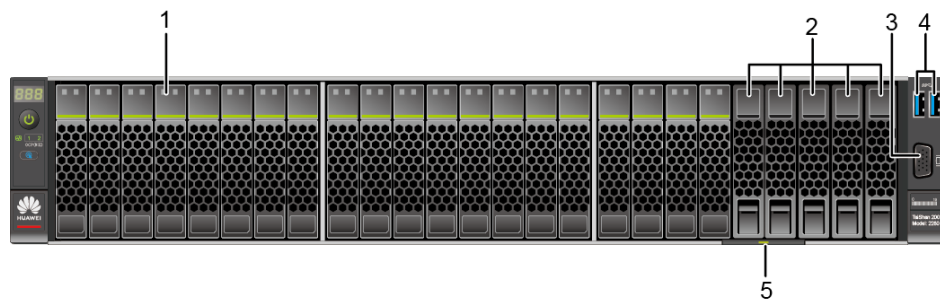
**Figure 2-2** Components on the front panel of a server with 25 x 2.5-inch drives



- 1 Drive
- 2 VGA port
- 3 USB 3.0 port
- 4 Label plate with an SN label

- **Figure 2-3** shows the components on the front panel of a server with 8 x 2.5-inch SAS/SATA drives and 12 x 2.5-inch NVMe SSDs.

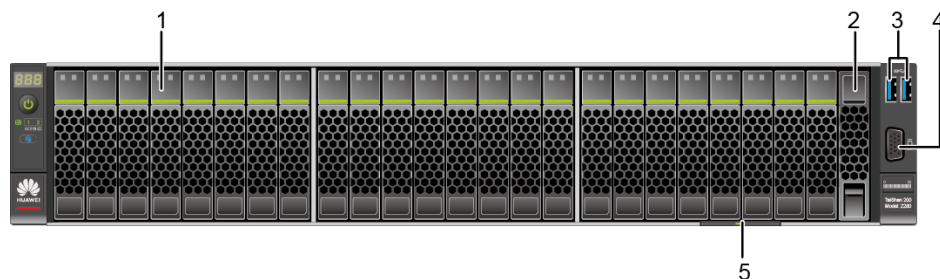
**Figure 2-3** Components on the front panel of a server with 8 x 2.5-inch SAS/SATA drives and 12 x 2.5-inch NVMe SSDs



- 1 Drive
- 2 Filler panel
- 3 VGA port
- 4 USB 3.0 port
- 5 Label plate with an SN label

- **Figure 2-4** shows the components on the front panel of a server with 24 x 2.5 SAS/SATA pass-through drives.

**Figure 2-4** Components on the front panel of a server with 24 x 2.5 SAS/SATA pass-through drives



1	Drive	2	Filler panel
3	USB 3.0 port	4	VGA port

5	Label plate with an SN label	-	-
---	------------------------------	---	---

**NOTE**

Servers with Kunpeng 920 5220 or 3210 processors do not support the configuration of 24 x 2.5-inch SAS/SATA pass-through drives.

**Table 2-1** Description of ports on the front panel

Port	Type	Description
USB port	USB 3.0	The USB ports allow USB devices to be connected to the server. <b>NOTE</b> <ul style="list-style-type: none"> <li>Before connecting an external USB device, check that the USB device functions properly. A server may operate abnormally if an abnormal USB device is connected.</li> <li>If an external USB device is used, the maximum length of the extension cable is 1 m.</li> </ul>
VGA port	DB15	The VGA port is connected to a terminal, such as a monitor or physical KVM. <b>NOTE</b> The VGA port on the front panel does not have cable screws. The VGA cable is easy to fall off. You are advised to use the VGA port on the rear panel.

**SN**

The serial number (SN) on the label is a string that uniquely identifies a server. The SN is required when you contact Huawei technical support.

Figure 2-5 shows the SN format.

**Figure 2-5** SN example





**Table 2-2** SN description

No.	Description
1	SN ID (two characters), which is <b>21</b> .
2	Material identification code (eight characters), that is, processing code.
3	Code of a processing factory (two characters). The value <b>10</b> indicates Huawei.
4	Year and month (two characters). <ul style="list-style-type: none"> <li>The first character indicates the year. Digits 1 to 9 indicate 2001 to 2009, letters A to H indicate 2010 to 2017, letters J to N indicate 2018 to 2022, and letters P to Y indicate 2023 to 2032.</li> </ul> <p><b>NOTE</b> The years from 2010 are represented by upper-case letters excluding I, O, and Z because the three letters are similar to digits 1, 0, and 2.</p> <ul style="list-style-type: none"> <li>The second character indicates the month. Digits 1 to 9 indicate January to September, and letters A to C indicate October to December.</li> </ul>
5	Serial number (six characters).
6	RoHS compliance (one character). <b>Y</b> indicates environment-friendly processing.
7	Board model, that is, product name.

## 2.2 Front Panel Indicators and Buttons

- **Figure 2-6** shows the indicators and buttons on the front panel of a server with 12 x 3.5-inch drives.

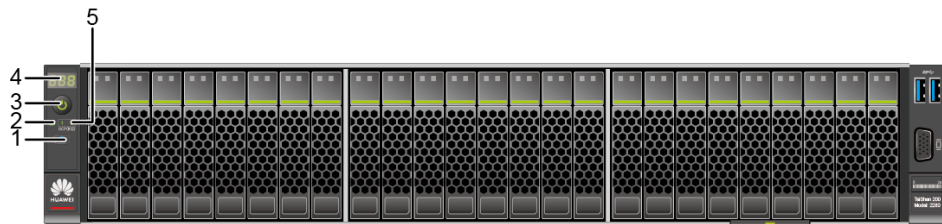
**Figure 2-6** Indicators and buttons on the front panel of a server with 12 x 3.5-inch drives



- |  |                        |
|--|------------------------|
| 1 UID button/indicator                 | 2 Health indicator     |
| 3 Power button/indicator               | 4 Fault diagnostic LED |
| 5 FlexIO presence indicators (1 and 2) | - -                    |

- **Figure 2-7** shows the indicators and buttons on the front panel of a server with 25 x 2.5-inch drives.

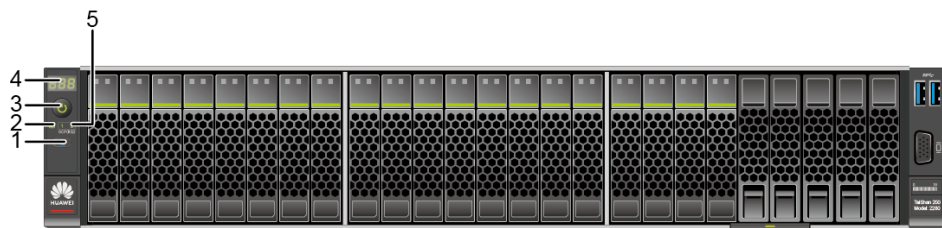
**Figure 2-7** Indicators and buttons on the front panel of a server with 25 x 2.5-inch drives



- |  |                        |
|--|------------------------|
| 1 UID button/indicator                 | 2 Health indicator     |
| 3 Power button/indicator               | 4 Fault diagnostic LED |
| 5 FlexIO presence indicators (1 and 2) | - -                    |

- **Figure 2-8** shows the indicators and buttons on the front panel of a server with 8 x 2.5-inch SAS/SATA drives and 12 x 2.5-inch NVMe SSDs.

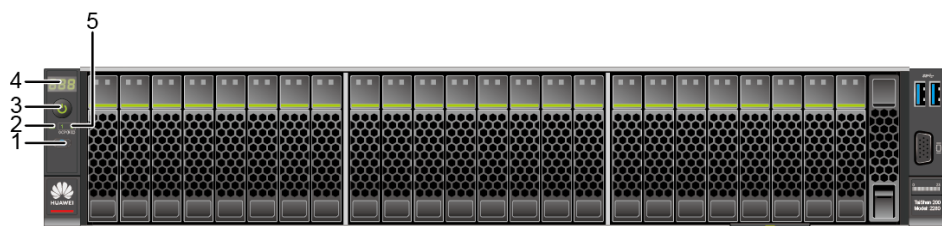
**Figure 2-8** Indicators and buttons on the front panel of a server with 8 x 2.5-inch SAS/SATA drives and 12 x 2.5-inch NVMe SSDs



- |  |                        |
|--|------------------------|
| 1 UID button/indicator                 | 2 Health indicator     |
| 3 Power button/indicator               | 4 Fault diagnostic LED |
| 5 FlexIO presence indicators (1 and 2) | - -                    |

- **Figure 2-9** shows the indicators and buttons on the front panel of a server 24 x 2.5 SAS/SATA pass-through drives.

**Figure 2-9** Indicators and buttons on the front panel of a server 24 x 2.5 SAS/SATA pass-through drives








1	UID button/indicator	2	Health indicator
3	Power button/indicator	4	Fault diagnostic LED
5	FlexIO presence indicators (1 and 2)	-	-

 **NOTE**

Servers with Kunpeng 920 5220 or 3210 processors do not support the configuration of 24 x 2.5-inch SAS/SATA pass-through drives.

**Table 2-3** Indicators and buttons on the front panel

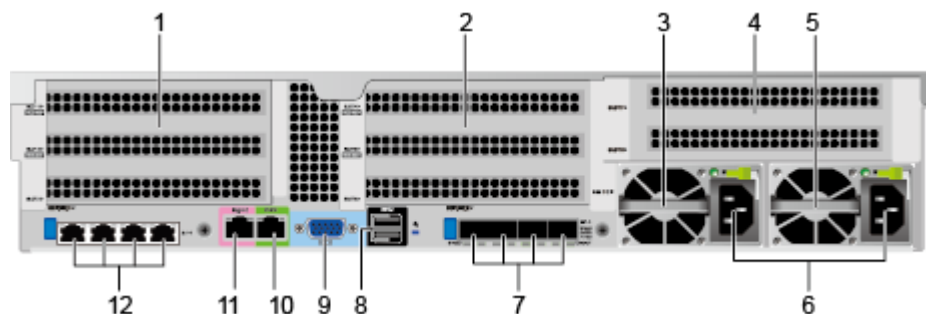
Silkscreen	Indicator/ Button	State Description
	Fault diagnostic LED	<ul style="list-style-type: none"> <li>• ---: The server is operating normally.</li> <li>• Error code: A server component is faulty.</li> </ul> <p>For details about error code, see the <a href="#">TaiShan Rack Server iBMC Alarm Handling</a>.</p>
	Power button/ indicator	<p>Power indicator</p> <ul style="list-style-type: none"> <li>• Steady yellow: The server is in the standby state.</li> <li>• Steady green: The server is properly powered on.</li> <li>• Blinking yellow: The iBMC is starting.</li> <li>• Off: The server is not connected to a power source.</li> </ul> <p>Power indicator</p> <ul style="list-style-type: none"> <li>• When the server is powered on, you can press this button to shut down the OS.</li> <li>• When the server is powered on, you can hold down this button for 6 seconds to force the server to power off.</li> <li>• When the server is in the standby state, you can press this button to start the server.</li> </ul>
	UID button/ indicator	<p>The UID button/indicator helps identify and locate a device.</p> <p>UID indicator:</p> <ul style="list-style-type: none"> <li>• Off: The device is not being located.</li> <li>• Blinking blue (blinking 255 seconds): The device has been located and is differentiated from other devices that have also been located.</li> <li>• Steady blue: The device is being located.</li> </ul> <p>UID button:</p> <ul style="list-style-type: none"> <li>• You can turn on, turn off, or blink the UID indicator by pressing the UID button on the panel or by using the iBMC CLI or WebUI.</li> <li>• You can press this button to turn on or off the UID indicator.</li> <li>• You can press and hold down this button for about 5 seconds to reset the iBMC.</li> </ul>

Silkscreen	Indicator/Button	State Description
	Health indicator	<ul style="list-style-type: none"> <li>Steady green: The server is operating properly.</li> <li>Blinking red at 1 Hz: A major alarm has been generated on the server.</li> <li>Blinking red at 5 Hz: A critical alarm has been generated on the server.</li> </ul>
	FlexIO presence indicators (1 and 2)	<ul style="list-style-type: none"> <li>1 and 2: The numbers 1 and 2 respectively represent FlexIOs 1 and 2.</li> <li>Steady green: The FlexIO is properly connected.</li> <li>Off: The FlexIO cannot be detected.</li> </ul>

## 2.3 Rear Panel Components

Figure 2-10 shows the components on the rear panel of the server.

Figure 2-10 Rear panel components



- |                                      |                                       |
|--------------------------------------|---------------------------------------|
| 1 I/O module 1                       | 2 I/O module 2                        |
| 3 Power supply unit (PSU) 1          | 4 I/O module 3                        |
| 5 PSU 2                              | 6 PSU socket                          |
| 7 FlexIO card 2 (connected to CPU 2) | 8 USB 3.0 port                        |
| 9 VGA port                           | 10 Serial port                        |
| 11 Management network port           | 12 FlexIO card 1 (connected to CPU 1) |

### NOTE

- I/O modules 1, 2, and 3 can be drive modules or riser modules. The preceding figure is for reference only.
- FlexIO card 1 or 2 can be a TM210 NIC, and only one TM280 NIC can be configured. The preceding figure is for reference only.
- FlexIO card 1 or 2 is not hot-swappable. If you need to replace it, power off the server.

**Table 2-4** Ports on the rear panel

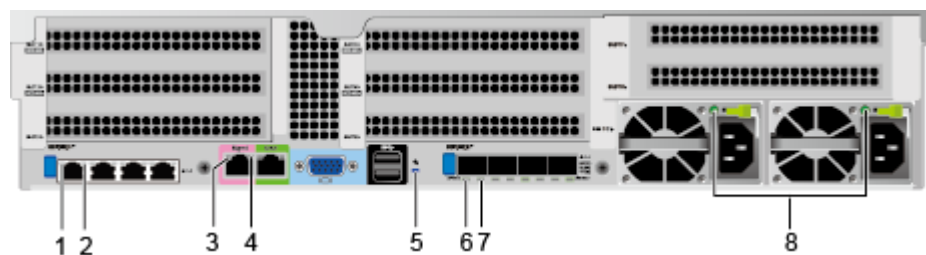
Port	Type	Quantity	Description
VGA port	DB15	1	The VGA port is connected to a terminal, such as a monitor or physical KVM.
USB port	USB 3.0	2	The USB ports allow USB devices to be connected to the server. <b>NOTE</b> Before connecting an external USB device, check that the USB device functions properly. A server may operate abnormally if an abnormal USB device is connected.
Management network port	RJ45	1	This 1000 Mbps Ethernet port is used for server management, and supports 10/100/1000 Mbps auto-negotiation.
Serial port	RJ45	1	The serial port is used as the system serial port by default. You can set it as the iBMC serial port by using the iBMC command. This port is used for debugging. <b>NOTE</b> For details about how to set the system serial port as the iBMC serial, see <b>Logging In over the Serial Port</b> in <b>8.2 Logging In to the iBMC CLI</b> .
GE electrical port	RJ45	4/8	<ul style="list-style-type: none"> <li>Each FlexIO card provides four GE electrical ports. A maximum of eight GE electrical ports can be provided through the two FlexIO cards.</li> <li>This 1000 Mbps Ethernet port is used for FlexIO card, and supports 10/100/1000 Mbps auto-negotiation.</li> </ul>
25GE optical port	SFP28	4	A FlexIO card can provide a maximum of four 25GE optical ports. <b>NOTE</b> The 25GE optical ports support rate adaptation to 10GE, and optical modules of different rates are required.

Port	Type	Quantity	Description
PSU socket	-	1/2	Determine the number of PSUs based on actual requirements, but ensure that the rated power of the PSUs is greater than that of the server. You are advised to configure two PSUs to ensure reliable device operating. When one PSU is used, <b>Predicted PSU Status</b> cannot be set to <b>Active/Standby</b> on the iBMC WebUI.

## 2.4 Rear Panel Indicators

Figure 2-11 shows the indicators on the rear panel of the server.

Figure 2-11 Rear panel indicators



- |   |   |
|---|---|
| 1 GE electrical port data transmission status indicator                       | 2 GE electrical port connection status indicator      |
| 3 Management network port data transmission status indicator                  | 4 Management network port connection status indicator |
| 5 UID indicator   | 6 Optical port transmission rate indicator            |
| 7 Optical port connection status indicator/data transmission status indicator | 8 PSU indicator                                       |

Table 2-5 Indicators on the rear panel

Indicator		State Description
GE electrical port/ Management network port	Data transmission status indicator	<ul style="list-style-type: none"> <li>Blinking yellow: Data is being transmitted.</li> <li>Off: No data is being transmitted.</li> </ul>
	Connection status indicator	<ul style="list-style-type: none"> <li>Steady green: The network port is properly connected.</li> <li>Off: The network port is not connected.</li> </ul>

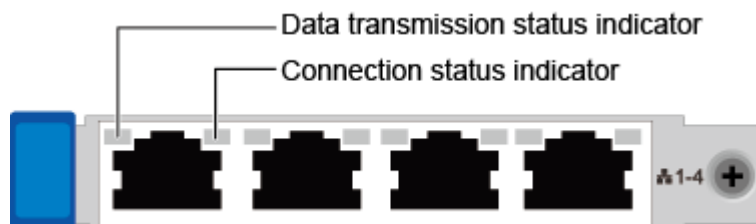
Indicator		State Description
UID indicator		<p>The UID indicator helps identify and locate a device.</p> <ul style="list-style-type: none"> <li>• Off: The device is not being located.</li> <li>• Blinking blue (blinking 255 seconds): The device has been located and is differentiated from other devices that have also been located.</li> <li>• Steady blue: The device is being located.</li> </ul> <p><b>NOTE</b> You can turn on, turn off, or blink the UID indicator by pressing the UID button or remotely running a command on the iBMC CLI.</p>
25 GE optical port	Transmission rate indicator	<ul style="list-style-type: none"> <li>• Steady green: The data transmission rate is 25 Gbit/s.</li> <li>• Steady yellow: The data transmission rate is 10 Gbit/s.</li> <li>• Off: The network port is not connected.</li> </ul>
	Connection status indicator/Data transmission status indicator	<ul style="list-style-type: none"> <li>• Steady green: The network port is properly connected.</li> <li>• Blinking green: Data is being transmitted.</li> <li>• Off: The network port is not connected.</li> </ul>
PSU indicator		<ul style="list-style-type: none"> <li>• Steady green: The power input and output are normal.</li> <li>• Steady orange: The input is normal, but no power output is supplied due to overheat protection, overcurrent protection, short circuit protection, output overvoltage protection, or some component failures.</li> <li>• Blinking green at 1 Hz: <ul style="list-style-type: none"> <li>– The input is normal, the server is standby.</li> <li>– The input is overvoltage or undervoltage. For details, see <a href="#">TaiShan Rack Server iBMC Alarm Handling</a>.</li> </ul> </li> <li>• Blinking green at 4 Hz: under online PSU firmware upgrade.</li> <li>• Off: No power is supplied.</li> </ul>

## 2.5 FlexIO Cards

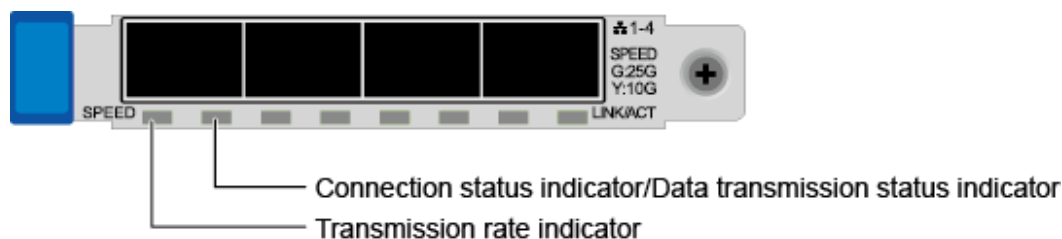
For details about FlexIO cards supported by the server, see the [Intelligent Computing Compatibility Checker](#). For details about the specifications and features of each FlexIO card, see the corresponding user guide.

The following figures show the indicators on the FlexIO cards.

**Figure 2-12** TM210 with four GE electrical ports



**Figure 2-13** TM280 with four 25GE optical ports



**Table 2-6** FlexIO card indicators

NIC Type	Indicator	State Description
FlexIO card with four GE electrical ports	Data transmission status indicator	<ul style="list-style-type: none"> <li>Blinking yellow: Data is being transmitted.</li> <li>Off: No data is being transmitted.</li> </ul>
	Connection status indicator	<ul style="list-style-type: none"> <li>Steady green: The network port is properly connected.</li> <li>Off: The network port is not connected.</li> </ul>
FlexIO card with four 25GE optical ports	Transmission rate indicator	<ul style="list-style-type: none"> <li>Steady green: The data transmission rate is 25 Gbit/s.</li> <li>Steady yellow: The data transmission rate is 10 Gbit/s.</li> <li>Off: The network port is not connected.</li> </ul>



NIC Type	Indicator	State Description
	Connection status indicator/Data transmission status indicator	<ul style="list-style-type: none"> <li>Steady green: The network port is properly connected.</li> <li>Blinking green: Data is being transmitted.</li> <li>Off: The network port is not connected.</li> </ul>

## 2.6 Drive Slot Numbers and Indicators

### 2.6.1 Drive Slot Numbers

- Figure 2-14 shows the drive slot numbers of a server with 12 x 3.5-inch drives in Expander mode.

Figure 2-14 Server with 12 x 3.5-inch drives in Expander mode

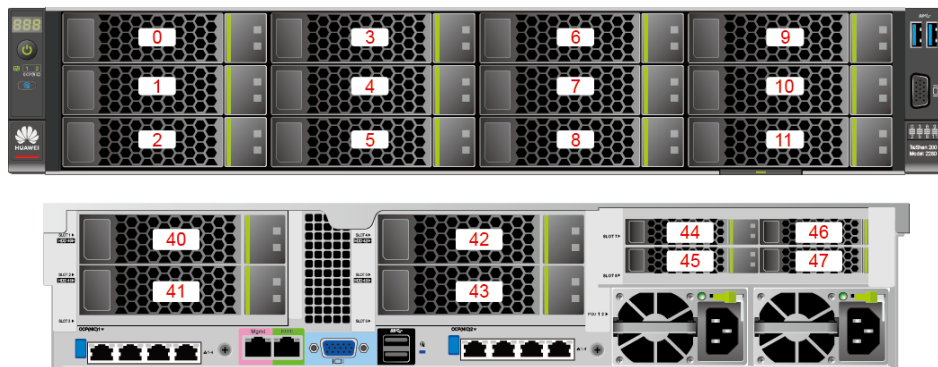
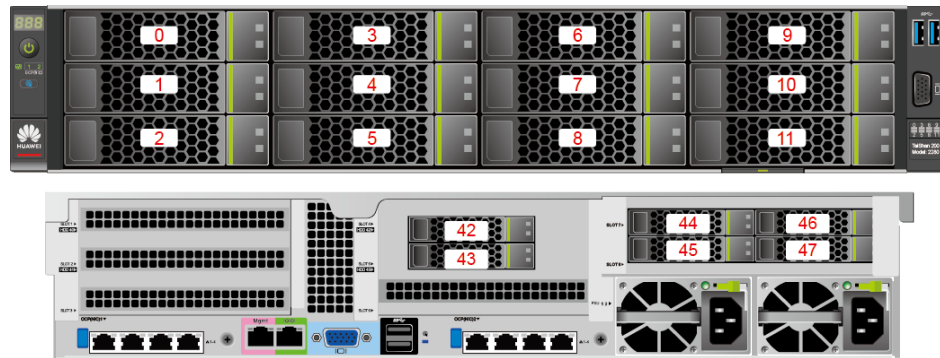


Table 2-7 Drive slot numbers of a server with 12 x 3.5-inch drives in Expander mode

Physical Slot Number	Slot Number Identified by iBMC	Slot Number Identified by RAID Controller
40	Disk40	12
41	Disk41	13
42	Disk42	14
43	Disk43	15

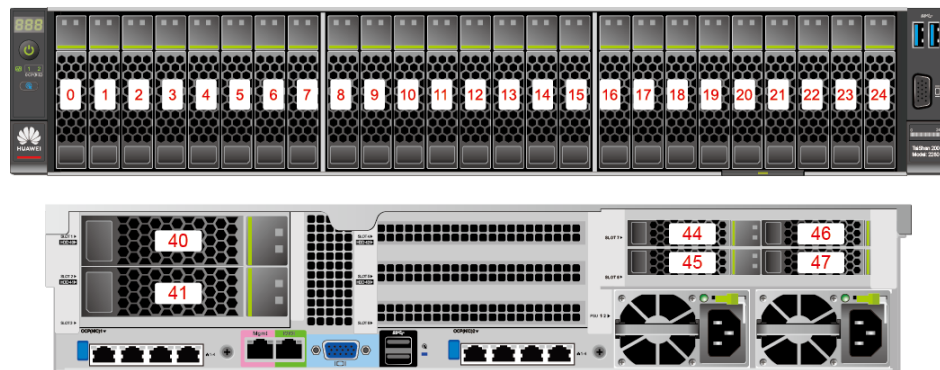
- Figure 2-15 shows the drive slot numbers of a server with 12 x 3.5-inch drives in pass-through mode.

**Figure 2-15** Server with 12 x 3.5-inch drives in pass-through mode



- **Figure 2-16** shows the drive slot numbers of a server with 25 x 2.5-inch drives in Expander mode.

**Figure 2-16** Server with 25 x 2.5-inch drives in Expander mode

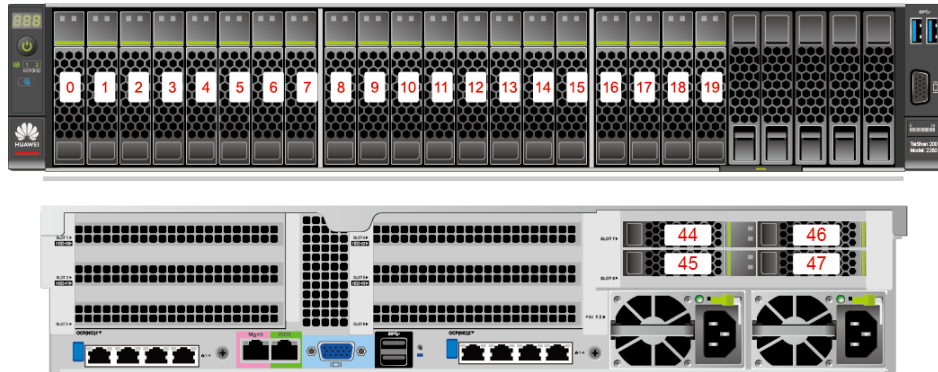


**Table 2-8** Drive slot numbers of a server with 25 x 2.5-inch drives in Expander mode

Physical Slot Number	Slot Number Identified by iBMC	Slot Number Identified by RAID Controller
40	Disk40	25
41	Disk41	26

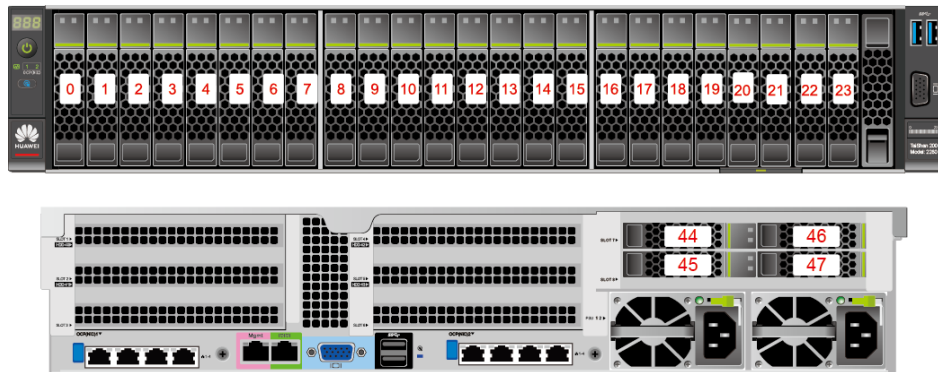
- **Figure 2-17** shows the drive slot numbers of a server with 8 x 2.5-inch SAS/ SATA drives and 12 x 2.5-inch NVMe SSDs.

**Figure 2-17** Server with 8 x 2.5-inch SAS/SATA drives and 12 x 2.5-inch NVMe SSDs



- **Figure 2-18** shows the drive slot numbers of a server with 24 x 2.5 SAS/SATA passthrough drives.

**Figure 2-18** Server with 24 x 2.5 SAS/SATA pass-through drives



**Table 2-9** Drive configurations

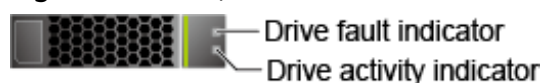
Configuration	Maximum Front Drives	Maximum Rear Drives	Drive Management Mode
Server with 25 x 2.5-inch drives in Expander mode <sup>[1]</sup>	25 (SAS/SATA drives)	<ul style="list-style-type: none"> <li>I/O module 1: 2 (SAS/SATA drives)</li> <li>I/O module 3<sup>[2]</sup>: 4 (NVMe SSDs)</li> </ul>	One RAID controller card
Server with 12 x 3.5-inch drives in Expander mode	12 (SAS/SATA drives)	<ul style="list-style-type: none"> <li>I/O module 1: 2 (SAS/SATA drives)</li> <li>I/O module 2: 2 (SAS/SATA drives)</li> <li>I/O module 3<sup>[2]</sup>: 4 (NVMe SSDs)</li> </ul>	One RAID controller card

Configuration	Maximum Front Drives	Maximum Rear Drives	Drive Management Mode
Server with 12 x 3.5-inch drives in pass-through mode <sup>[3]</sup>	12 (SAS/SATA drives)	<ul style="list-style-type: none"> <li>I/O module 2: 2 (SAS/SATA drives)</li> <li>I/O module 3<sup>[2]</sup>: 4 (NVMe SSDs)</li> </ul>	CPU over SAS
Server with 8 x 2.5-inch SAS/SATA drives and 12 x 2.5-inch NVMe SSDs <sup>[1]</sup>	20 <ul style="list-style-type: none"> <li>Slots 0 to 7 support only SAS/SATA drives.</li> <li>Slots 8 to 19 support only NVMe SSDs.<sup>[4]</sup></li> </ul>	I/O module 3 <sup>[2]</sup> : 4 (NVMe SSDs)	One RAID controller card
Server with 24 x 2.5-inch drives in pass-through mode	24 (SAS/SATA drives)	I/O module 3 <sup>[2]</sup> : 4 (NVMe SSDs)	CPU over SAS
<ul style="list-style-type: none"> <li>[1]: The front drives in a server with 25 x 2.5-inch drives in Expander mode or a server with 8 x 2.5-inch SAS/SATA drives + 12 x 2.5-inch NVMe SSDs can only be 2.5-inch drives, and the front drives in a server with 12 x 3.5-inch drives in Expander mode or a server with 12 x 3.5-inch drives in pass-through mode can only be 3.5-inch drives.</li> <li>[2]: I/O module 3 supports 2.5-inch NVMe drives, and the PCIe signals are output through CPU 2. I/O modules 1 and 2 support 2.5-inch and 3.5-inch drives.</li> <li>[3]: CPU SAS pass-through requires a SAS riser card. By default, it is installed on I/O module 2.</li> <li>[4]: The NVMe SSDs in slots 8 to 19 of a server with 8 x 2.5-inch SAS/SATA drives + 12 x 2.5-inch NVMe SSDs support only PCIe 3.0.</li> <li>[5]: Servers with Kunpeng 920 5220 or 3210 processors do not support the configuration of 24 x 2.5-inch SAS/SATA pass-through drives.</li> </ul>			

## 2.6.2 SAS/SATA Drive Indicators

Figure 2-19 shows the SAS/SATA drive indicators.

Figure 2-19 SAS/SATA drive indicators



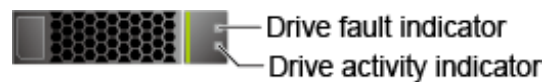
**Table 2-10** Description of SAS/SATA drive indicators

Drive Activity Indicator (Green Indicator)	Drive Fault Indicator (Yellow Indicator)	Description
Steady on	Off	The drive is in position.
Blinking at 4 Hz	Off	Data is being read or written normally, or data on the primary drive is being rebuilt.
Steady on	Blinking at 1 Hz	The drive is being located by the RAID controller card.
Blinking at 1 Hz	Blinking at 1 Hz	The data on the secondary drive is being rebuilt.
Off	Steady on	A member drive in the RAID array is removed.
Steady on	Steady on	A member drive in the RAID array is faulty.

## 2.6.3 NVMe SSD Indicators

Figure 2-20 shows the NVMe SSD indicators.

**Figure 2-20** NVMe SSD indicators



**Table 2-11** NVMe SSD indicators

Drive Activity Indicator (Green Indicator)	Drive Fault Indicator (Yellow Indicator)	State Description
Off	Off	The NVMe SSD cannot be detected.
Steady green	Off	The NVMe SSD is detected and working properly.
Blinking green (2 Hz)	Off	Data is being read from or written to the NVMe SSD.
Off	Blinking yellow (2 Hz)	The NVMe SSD is being located or hot-swapped.
Off	Blinking yellow at 0.5 Hz	The NVMe SSD completes the hot removal process and is removable.

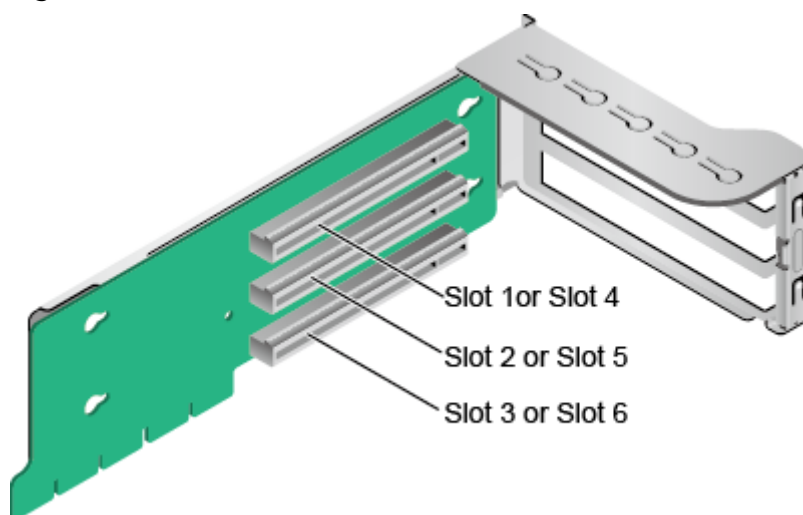
Drive Activity Indicator (Green Indicator)	Drive Fault Indicator (Yellow Indicator)	State Description
Steady green or off	Steady yellow	The NVMe SSD is faulty.

## 2.7 Riser Cards and PCIe Slots

Figure 2-21, Figure 2-22, Figure 2-23, Figure 2-24, and Figure 2-25 show riser cards supported by I/O modules 1 and 2 in a 2280.

- The riser card shown in Figure 2-21 can be installed in I/O module 1 or 2. It provides PCIe slots 1 to 3 when installed in I/O module 1 and PCIe slots 4 to 6 when installed in I/O module 2.

Figure 2-21 Riser card 1 (three x8 slots)

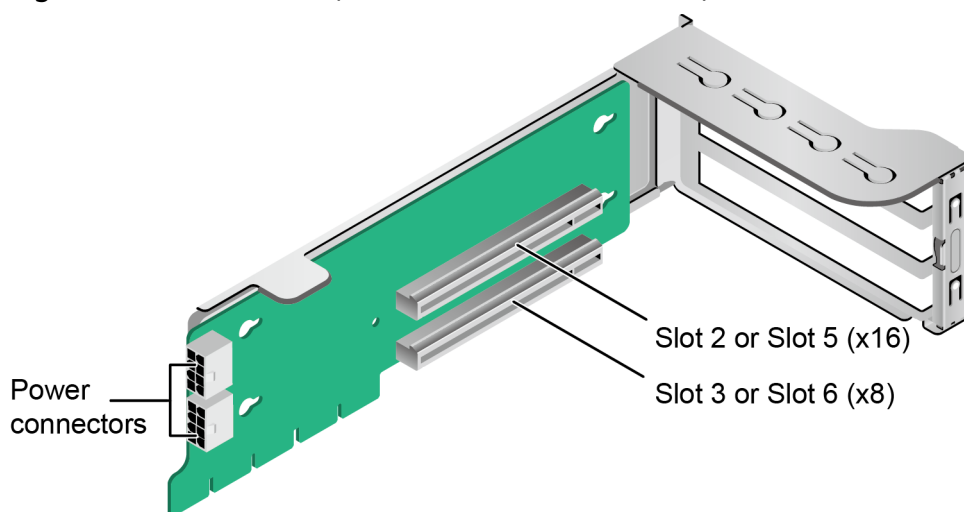


- The riser card shown in Figure 2-22 supports full-height full-length dual-width GPUs. It provides PCIe slots 2 and 3 when installed in I/O module 1 and PCIe slots 5 and 6 when installed in I/O module 2.

### NOTE

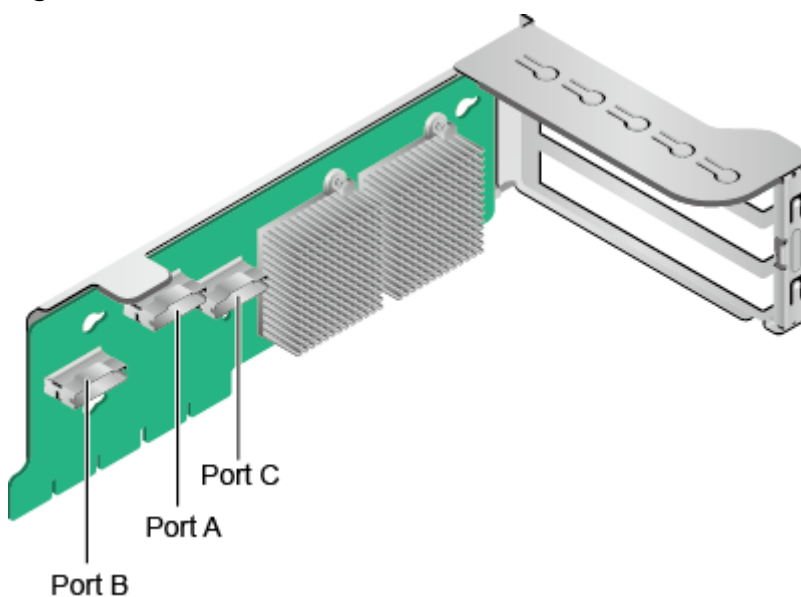
- The card must be used together with the power cables delivered with the server. Do not use the power cables of other servers.
- Only slots 2 and 5 support full-height full-length dual-width GPUs.

**Figure 2-22** Riser card 2 (one x8 slot and one x16 slot)



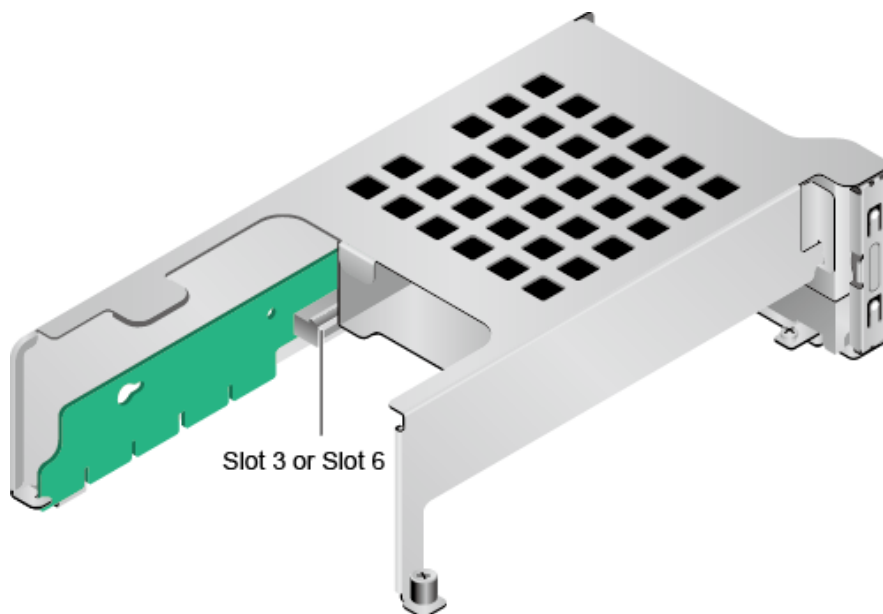
- The riser card shown in [Figure 2-23](#) is required for I/O module 1 or 2 in a server with 8 x 2.5-inch SAS/SATA drives and 12 x 2.5-inch NVMe SSDs. Ports A, B, and C are Slimline cable connectors.

**Figure 2-23** Riser card 3 (dedicated for a server with 12 NVMe SSDs)



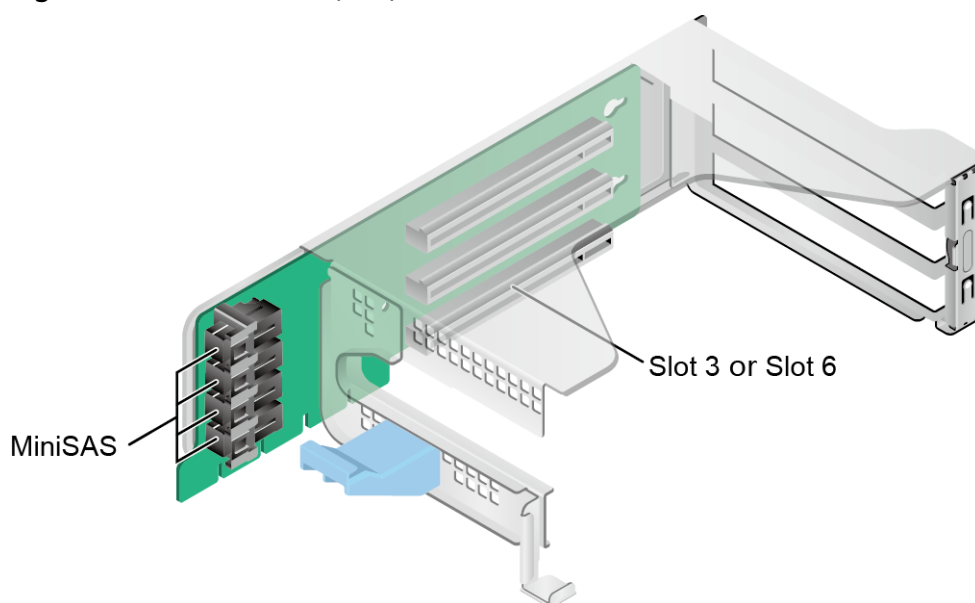
- When configured with two 2.5-inch rear drives respectively, both I/O modules 1 and 2 support x16 riser cards, as shown in [Figure 2-24](#). This riser card provides slot 3 when installed in I/O module 1, and slot 6 when installed in I/O module 2.

**Figure 2-24** Riser card 4 (one x16 slot)



- When the server is configured with Kunpeng 920 7260, 5250, or 5230 processors, the SAS riser card shown in [Figure 2-25](#) can be installed in I/O module 1 or 2. By default, it is installed in I/O module 2. When installed in I/O module 1, it occupies PCIe slots 1 to 3 and only slot 3 (x8) is available. When installed in I/O module 2, it occupies PCIe slots 4 to 6 and only slot 6 (x8) is available. When the server is configured with Kunpeng 920 5220 or 3210 processors, the SAS riser card can be installed only in I/O module 2 and occupies PCIe slots 4 to 6. Slots 4 and 5 do not output signals, and slot 6 supports x8 signals.

**Figure 2-25** Riser card 5 (SAS)

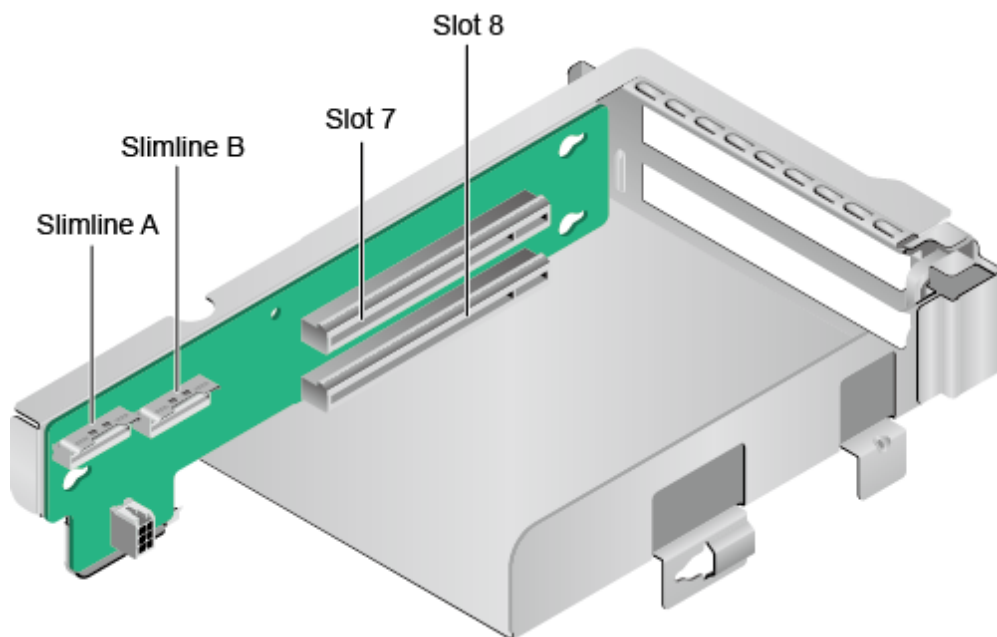


[Figure 2-26](#) and [Figure 2-27](#) show riser cards supported by I/O module 3.

- When installed in I/O module 3, the riser card shown in [Figure 2-26](#) provides PCIe slots 7 and 8

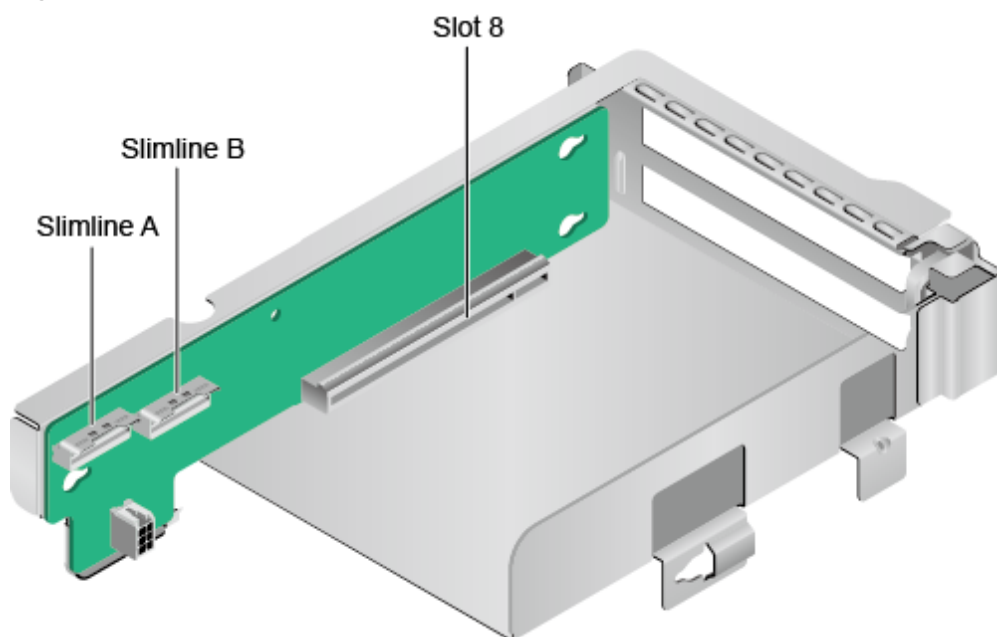


**Figure 2-26** Riser card 6 (two x8 slots)



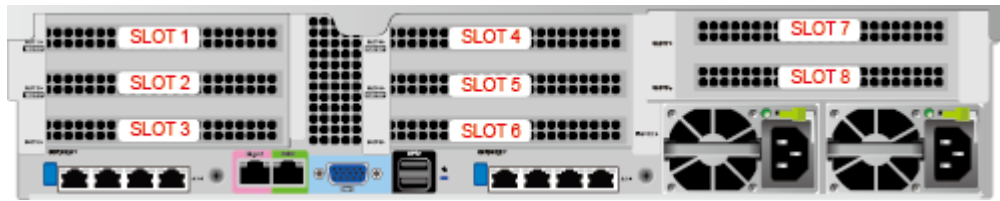
- When installed in I/O module 3, the riser card shown in [Figure 2-27](#) provides PCIe slot 8.

**Figure 2-27** Riser card 7 (one x16 slot)



[Figure 2-28](#) shows the rear PCIe slots of the 2280.

**Figure 2-28** PCIe slots



I/O module 1 provides slots 1 to 3, I/O module 2 provides slots 4 to 6, and I/O module 3 provides slots 7 and 8.

- If I/O module 1 uses a 2-slot PCIe riser module, slot 1 is unavailable.
- If I/O module 2 uses a 2-slot PCIe riser module, slot 4 is unavailable.
- If I/O module 3 uses a 1-slot PCIe riser module, slot 7 is unavailable.

**Table 2-12** describes specifications of the PCIe slots.

**Table 2-12** PCIe slot description

PCIe Slot	CPU	PCIe Standard	Connect or Width	Bus Width	Port Number in the BIOS	ROOT PORT (B/D/F)	Device (B/D/F)	Slot Size
Slot1	CPU1	PCIe 4.0	x16	<ul style="list-style-type: none"> <li>• 2-slot PRM: N/A</li> <li>• 3-slot PRM: x8</li> <li>• SAS PRM: N/A</li> </ul>	Port0	00/00/0	-	Full-height full-length
Slot2	CPU1	PCIe 4.0	x16	<ul style="list-style-type: none"> <li>• 2-slot PRM: x16</li> <li>• 3-slot PRM: x8</li> <li>• SAS PRM: N/A</li> </ul>	Port4	00/04/0	-	Full-height full-length
Slot3	CPU1	PCIe 4.0	x16	<ul style="list-style-type: none"> <li>• Single-slot PRM: x16</li> <li>• 2-slot PRM: x8</li> <li>• 3-slot PRM: x8</li> <li>• SAS PRM: x8</li> </ul>	Port1 2	00/0C/0	-	Full-height half-length

PCIe Slot	CPU	PCIe Standards	Connector Width	Bus Width	Port Number in the BIOS	ROOT PORT (B/D/F)	Device (B/D/F)	Slot Size
Slot4	CPU2	PCIe 4.0	x16	<ul style="list-style-type: none"> <li>• 2-slot PRM: N/A</li> <li>• 3-slot PRM: x8</li> <li>• SAS PRM: N/A</li> </ul>	Port0	80/00/0	-	Full-height full-length
Slot5	CPU2	PCIe 4.0	x16	<ul style="list-style-type: none"> <li>• 2-slot PRM: x16</li> <li>• 3-slot PRM: x8</li> <li>• SAS PRM: N/A</li> </ul>	Port4	80/04/0	-	Full-height full-length
Slot6	CPU2	PCIe 4.0	x16	<ul style="list-style-type: none"> <li>• Single-slot PRM: x16</li> <li>• 2-slot PRM: x8</li> <li>• 3-slot PRM: x8</li> <li>• SAS PRM: x8</li> </ul>	Port16	80/10/0	-	Full-height half-length
Slot7	CPU2	PCIe 4.0	x16	<ul style="list-style-type: none"> <li>• Single-slot PRM: N/A</li> <li>• 2-slot PRM: x8</li> </ul>	Port8	80/08/0	-	Full-height half-length
Slot8	CPU2	PCIe 4.0	x16	<ul style="list-style-type: none"> <li>• Single-slot PRM: x16</li> <li>• 2-slot PRM: x8</li> </ul>	Port12	80/0C/0	-	Full-height half-length
RAID controller card	CPU1	PCIe 4.0	x8	x8	Port8	00/08/0	-	-

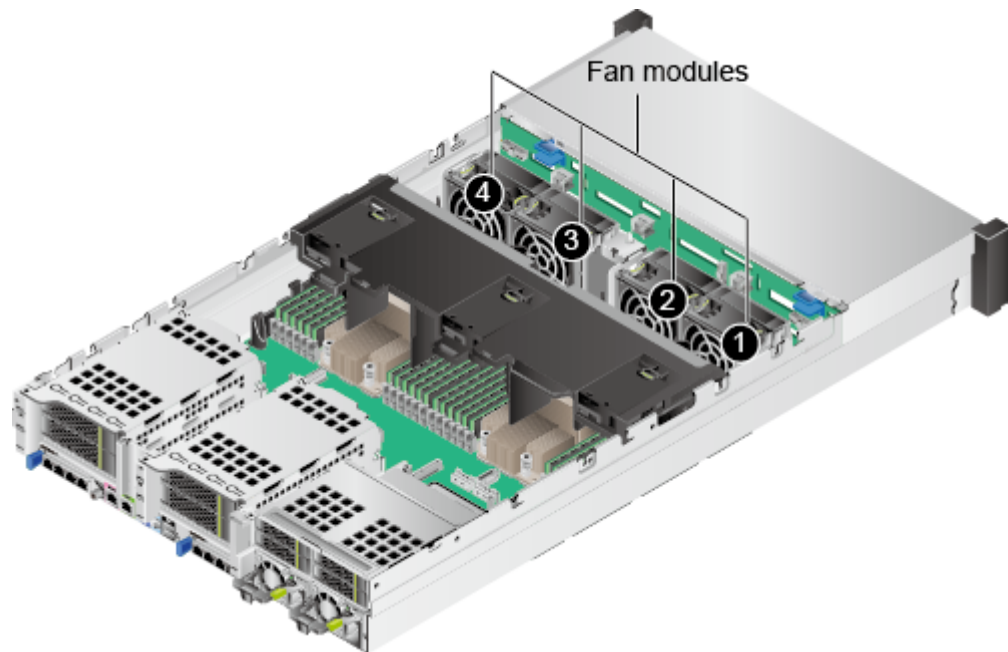
PCIe Slot	CPU	PCIe Standards	Connect or Width	Bus Width	Port Number in the BIOS	ROOT PORT (B/D/F)	Device (B/D/F)	Slot Size
<p><b>NOTE</b></p> <ul style="list-style-type: none"> <li>• A PCIe slot that supports a full-height full-length PCIe card is backward compatible with a full-height half-length or half-height half-length PCIe card. A PCIe slot that supports a full-height half-length PCIe card is backward compatible with a half-height half-length PCIe card.</li> <li>• A PCIe slot that supports a PCIe x16 card is backward compatible with a PCIe x8, x4, or x2 card. A PCIe slot that supports a PCIe x8 card is backward compatible with a PCIe x4, or x2 card.</li> <li>• All slots support PCIe cards of up to 75 W. The power of a PCIe card varies depending on its model. For details about supported PCIe cards, use the <a href="#">Intelligent Computing Compatibility Checker</a>. For PCIe cards not listed by the Intelligent Computing Compatibility Checker, contact the local Huawei sales personnel to submit the compatibility test requirements.</li> <li>• When two 2.5-inch drives are installed in I/O module 1 or 2, this module also supports a PCIe x16 riser card in slot 3 or 6.</li> <li>• B/D/F indicates Bus/Device/Function Number.</li> <li>• ROOT PORT (B/D/F) indicates the B/D/F of a CPU internal PCIe root port. Device (B/D/F) indicates the B/D/F (displayed on the OS) of an onboard or external PCIe port.</li> <li>• This table lists the default B/D/F. The value may be different if the server is not fully configured with PCIe cards, fully configured with PCIe cards of different models or in different slots, or configured with a PCIe card with a PCI bridge.</li> <li>• Atlas 300C accelerator cards are supported and dedicated riser cards are required. For details, see <a href="#">Intelligent Computing Compatibility Checker</a>.</li> </ul>								

## 2.8 Fan Modules

The fan speed can be adjusted. In normal cases, the fans run at the minimum speed. If the temperature at the air intake vent or the server temperature increases, the speed will increase accordingly.

[Figure 2-29](#) shows the fan modules.

**Figure 2-29** Fan modules



**NOTE**

The preceding figure uses the 2280 configured with Kunpeng 920 7260, 5250, or 5230 processors as an example. Fan positions are the same for the 2280 with Kunpeng 920 5220 or 3210 processors.

# 3 Product Specifications

For details about the part numbers and compatibility, use the [Intelligent Computing Compatibility Checker](#).

## 3.1 Technical Specifications

**Table 3-1** Technical specifications

Item	Server Powered by Kunpeng 920 7260, 5250, or 5230 Processors	Server Powered by Kunpeng 920 5220 or 3210 Processors
Form factor	2U rack server	
Processor	<ul style="list-style-type: none"> <li>• Number of processors: two 64-core, 48-core, or 32-core processors with the frequency of 2.6 GHz</li> <li>• Inter-processor communication: two Hydra links between the processors, with a maximum speed of 30 Gbit/s each</li> <li>• L3 cache capacity: up to 64 MB</li> </ul>	<ul style="list-style-type: none"> <li>• Number of processors: two 32-core or 24-core processors with the frequency of 2.6 GHz</li> <li>• Inter-processor communication: one Hydra link with a maximum speed of 30 Gbit/s</li> <li>• L3 cache capacity: up to 32 MB</li> </ul>

Item	Server Powered by Kunpeng 920 7260, 5250, or 5230 Processors	Server Powered by Kunpeng 920 5220 or 3210 Processors
Memory	<ul style="list-style-type: none"> <li>• Maximum number of slots: 32 DDR4 slots supporting RDIMMs</li> <li>• Maximum memory speed: 2933 MT/s</li> <li>• Memory protection functions: ECC, SEC/DED, SDDC, and patrol scrubbing</li> <li>• Capacity of a single DIMM: 16 GB, 32 GB, 64 GB, or 128 GB</li> </ul> <p><b>NOTE</b> DIMMs of different specifications (such as the capacity, bit width, rank, and height) cannot be installed in one server. That is, all DIMMs on one server must have the same part No.</p>	<ul style="list-style-type: none"> <li>• Maximum number of slots: 16 DDR4 slots supporting RDIMMs</li> <li>• Maximum memory speed: 2933 MT/s</li> <li>• Memory protection functions: ECC, SEC/DED, SDDC, and patrol scrubbing</li> <li>• Capacity of a single DIMM: 16 GB, 32 GB, 64 GB, or 128GB</li> </ul> <p><b>NOTE</b> DIMMs of different specifications (such as the capacity, bit width, rank, and height) cannot be installed in one server. That is, all DIMMs on one server must have the same part No.</p>
Storage	<p>Drive:</p> <ul style="list-style-type: none"> <li>• Support for a variety of drive configurations. For details, see <a href="#">Table 2-9</a>.</li> <li>• Hot swap of a single drive.</li> </ul> <p>RAID controller card:</p> <ul style="list-style-type: none"> <li>• Support for a variety of RAID controller cards. Use the <a href="#">Intelligent Computing Compatibility Checker</a> to obtain information about the specific RAID controller cards supported.</li> <li>• Supercapacitor to protect cache data from power failures, and support for RAID level migration, drive roaming, self-diagnosis, and web-based configuration. For details about the RAID controller card, see the <a href="#">TaiShan Server RAID Controller Card User Guide</a>.</li> </ul>	
FlexIO card	<p>A maximum of two FlexIO cards. A FlexIO card can provide either of the following network ports:</p> <ul style="list-style-type: none"> <li>• Four GE electrical ports, supporting PXE</li> <li>• Four 25GE/10GE optical ports, supporting PXE</li> </ul> <p><b>NOTE</b> Different optical modules can be used to support 25GE or 10GE optical port rate.</p>	

Item	Server Powered by Kunpeng 920 7260, 5250, or 5230 Processors	Server Powered by Kunpeng 920 5220 or 3210 Processors
PCIe slot	<ul style="list-style-type: none"> <li>● A maximum of nine PCIe 4.0 slots: one for a RAID controller card and eight for PCIe cards. The specifications of PCIe 4.0 slots are as follows: I/O modules 1 and 2 provide the following PCIe slots:               <ul style="list-style-type: none"> <li>- Two standard full-height full-length PCIe 4.0 x16 slots (width: PCIe 4.0 x8) and one standard full-height half-length PCIe 4.0 x16 slot (width: PCIe 4.0 x8)</li> <li>- One standard full-height full-length PCIe 4.0 x16 slot and one standard full-height half-length PCIe 4.0 x16 slot (width: PCIe 4.0 x8)</li> </ul> </li> <li>I/O module 3 provides the following PCIe slots:               <ul style="list-style-type: none"> <li>- Two standard half-height half-length PCIe 4.0 x16 slots (width: PCIe 4.0 x8)</li> <li>- One standard half-height half-length PCIe 4.0 x16 slot</li> </ul> </li> <li>● The PCIe expansion slots fully support Huawei proprietary PCIe SSD cards, which bolster I/O performance for applications such as searching, caching, and download services.</li> <li>● The PCIe slots support Huawei-developed Atlas 300 AI accelerator cards to implement fast and efficient processing and inference, and image identification and processing.</li> </ul> <p><b>NOTE</b> For details about the PCIe card models supported by the 2280, use the <a href="#">Intelligent Computing Compatibility Checker</a>.</p>	
Port	<ul style="list-style-type: none"> <li>● Front panel: two USB 3.0 ports and one DB15 VGA port</li> <li>● Rear panel: two USB 3.0 ports, one DB15 VGA port, one RJ45 serial port, and one RJ45 management network port</li> </ul>	
Fan module	<p>Four hot-swappable fan modules, providing protection against single-fan failure</p> <p><b>NOTE</b> Fan modules of the same part No. must be used in a server.</p>	
System management	<p>Huawei iBMC supports Intelligent Platform Management Interface (IPMI), Serial over LAN (SOL), KVM over IP, and virtual media, and provides one 10/100/1000 Mbps RJ45 management network port.</p>	
Security	<ul style="list-style-type: none"> <li>● Administrator password</li> <li>● Front bezel (optional)</li> </ul> <p><b>NOTE</b> The front bezel is installed on the front panel and comes with a security lock to prevent unauthorized operations on drives.</p>	



Item	Server Powered by Kunpeng 920 7260, 5250, or 5230 Processors	Server Powered by Kunpeng 920 5220 or 3210 Processors
Video card	<p>The video card chip SM750 is integrated in the iBMC management chip. It provides 32 MB video memory and supports the maximum display resolution of 1920 x 1080 at 60 Hz with 16 M colors.</p> <p><b>NOTE</b></p> <ul style="list-style-type: none"> <li>• Only the maximum resolution supported by the OS built-in driver is supported.</li> <li>• If both the front and rear VGA ports are connected to monitors, only the monitor connected to the front VGA port is available.</li> </ul>	

## 3.2 Environmental Specifications

Table 3-2 Environmental specifications

Category	Specifications
Temperature	<ul style="list-style-type: none"> <li>• Operating temperature: 5°C to 40°C (41°F to 104°F) (ASHRAE Classes A2 and A3 compliant)</li> <li>• Storage temperature (≤ 72 hours): -40°C to +65°C (-40°F to +149°F)</li> <li>• Long-term storage temperature (&gt; 72 hours): 21°C to 27°C (69.8°F to 80.6°F)</li> <li>• Maximum temperature change rate: 20°C/h (36°F/h)</li> </ul> <p><b>NOTE</b> The highest operating temperature varies depending on the configuration. For details, see <a href="#">Table 3-3</a>.</p>
Relative humidity (RH, non-condensing)	<ul style="list-style-type: none"> <li>• Operating humidity: 8% to 90%</li> <li>• Storage humidity (≤ 72 hours): 5% to 95%</li> <li>• Long-term storage humidity (&gt; 72 hours): 30% to 69%</li> <li>• Maximum change rate: 20%/h</li> </ul>
Air volume	≥204CFM

Category	Specifications
Altitude	<p>3050 m (10000 ft.)</p> <p><b>NOTE</b> ASHRAE 2015 compliant:</p> <ul style="list-style-type: none"> <li>• ASHRAE Class A1 and A2 compliant: For altitudes above 900 m (2952.72 ft.), the highest operating temperature decreases by 1°C (1.8°F) for every increase of 300 m (984.24 ft.) in altitude.</li> <li>• ASHRAE Class A3 compliant: For altitudes above 900 m (2952.72 ft.), the highest operating temperature decreases by 1°C (1.8°F) for every increase of 175 m (574.15 ft.) in altitude.</li> <li>• ASHRAE Class A4 compliant: For altitudes above 900 m (2952.72 ft.), the highest operating temperature decreases by 1°C (1.8°F) for every increase of 125 m (410.10 ft.) in altitude.</li> </ul>
Corrosive gaseous contaminant	<p>Maximum corrosion product thickness growth rate:</p> <ul style="list-style-type: none"> <li>• Copper corrosion rate test: 300 Å/month (meeting level G1 requirements of the ANSI/ISA-71.04-2013 standard on gaseous corrosion)</li> <li>• Silver corrosion rate test: 200 Å/month</li> </ul>
Particle contaminant	<ul style="list-style-type: none"> <li>• The equipment room environment meets the requirements of ISO 14664-1 Class 8.</li> <li>• There is no explosive, conductive, magnetic, or corrosive dust in the equipment room.</li> </ul> <p><b>NOTE</b> It is recommended that the particulate pollutants in the equipment room be monitored by a professional organization.</p>
Acoustic noise	<p>The declared A-weighted sound power levels (LWAd) and declared average bystander position A-weighted sound pressure levels (LpAm) listed are measured at 23°C (73.4°F) in accordance with ISO 7779 (ECMA 74) and declared in accordance with ISO 9296 (ECMA 109).</p> <ul style="list-style-type: none"> <li>• Idle: <ul style="list-style-type: none"> <li>- LWAd: 5.64 Bels</li> <li>- LpAm: 41 dBA</li> </ul> </li> <li>• Operating: <ul style="list-style-type: none"> <li>- LWAd: 6.24 Bels</li> <li>- LpAm: 46.6 dBA</li> </ul> </li> </ul> <p><b>NOTE</b> Actual sound levels generated during operation vary depending on server configuration, load, and ambient temperature.</p>

**Table 3-3** Operating temperature limitations

Model	Max. 30°C (86°F)	Max. 35°C (95°F) (ASHRAE Class A2 Compliant)	Max. 40°C (104°F) (ASHRAE Class A3 Compliant)
EXP model with 12 x 3.5-inch drives	Supports all configurations	Supports all configurations.	<ul style="list-style-type: none"> <li>Does not support 64-core CPUs.</li> <li>Does not support PCIe SSD cards</li> <li>Does not support passive cooling GPUs (including DMINI cards).</li> <li>Does not support rear drives</li> </ul>
Pass-through model with 12 x 3.5-inch drives			
EXP model with 25 x 2.5-inch drives			
Pass-through model with 24 x 2.5-inch drives			
Server with 8 x 2.5-inch SAS/SATA drives and 12 x 2.5-inch NVMe SSDs	Supports all configurations	Supports all configurations.	Not supported
<p><b>NOTE</b></p> <ul style="list-style-type: none"> <li>If one fan fails, the highest operating temperature of the server is 5°C (9°F) lower than that in normal cases.</li> <li>When powered by Kunpeng 920 5220 or 3210 processors, the server does not support 24 x 2.5 SAS/SATA pass-through drives.</li> </ul>			

## 3.3 Physical Specifications

**Table 3-4** Physical specifications

Item	Description
Dimensions (H x W x D)	Chassis with 3.5-inch drives: 86.1 mm (2U) x 447 mm x 790 mm (3.39 in. x 17.60 in. x 31.10 in.) Chassis with 2.5-inch drives: 86.1 mm (2U) x 447 mm x 790 mm (3.39 in. x 17.60 in. x 31.10 in.)

Item	Description
Installation space	<p>Requirements for cabinet installation (cabinet compliant with the International Electrotechnical Commission (IEC) 297 standard):</p> <ul style="list-style-type: none"> <li>● Cabinet width: 482.6 mm (19 in.)</li> <li>● Cabinet depth: ≥ 1000 mm (39.37 in.)</li> </ul> <p>Requirements for guide rail installation:</p> <ul style="list-style-type: none"> <li>● L-shaped guide rails: apply only to Huawei cabinets.</li> <li>● Adjustable guide rails: apply to a cabinet with a distance of 543.5 mm to 848.5 mm (21.40 in. to 33.41 in.) between the front and rear mounting bars.</li> </ul>
Weight in full configuration	<p>Net weight:</p> <ul style="list-style-type: none"> <li>● Server with 12 x 3.5-inch front drives + 4 x 3.5-inch rear drives + 4 x 2.5-inch rear drives: 32 kg (70.55 lb)</li> <li>● Server with 25 x 2.5-inch front drives + 2 x 3.5-inch rear drives + 4 x 2.5-inch rear drives: 25 kg (55.12 lb)</li> <li>● Server with 8 SAS front drives + 12 front NVMe SSDs + 4 x 2.5-inch rear drives: 24 kg (52.91 lb)</li> <li>● Server with 24 x 2.5-inch front drives + 4 x 2.5-inch rear drives: 24 kg (52.91 lb)</li> </ul> <p>Packaging materials: 5 kg (11.03 lb)</p>
Power consumption	<p>The power consumption parameters vary according to configurations (including the ErP standard configuration of the European Union). Use the <a href="#">Intelligent Computing Product Power Calculator</a> to obtain the specific power consumption value.</p>

### 3.4 PSU Specifications

- The PSUs are hot-swappable and work in 1+1 redundancy mode.
- For details about supported PSUs, use the [Intelligent Computing Compatibility Checker](#).
- The recommended current specifications for the external power circuit breaker connected to the server are as follows:
  - AC power supply: 32 A
  - DC power supply: 63 A
- A server must use PSUs of the same model.
- The PSUs provide short-circuit protection. The PSUs that support dual input live wires provide double-pole fuse.
- If the input voltage ranges from 200 V to 220 V AC, the output power of the 2000 W AC platinum PSU decreases to 1800 W.

# 4 Software and Hardware Compatibility

---

Use the [Intelligent Computing Compatibility Checker](#) to obtain information about the operating systems and hardware supported by the server.

---

## NOTICE

Do not use incompatible components. Otherwise, the server may fail to work properly. The technical support and warranty do not cover faults caused by incompatible components.

---

# 5 Install and Configure



## 5.1 Tool Preparations










Prepare the following tools:

- ESD wrist strap or ESD gloves
- M3 Phillips screwdriver
- Protective gloves
- ESD bag
- Flat-head screwdriver

## 5.2 Safety Symbols on Devices

Table 5-1 Safety labels

Label	Meaning	Description
	Warning	This label indicates that wrong operations may cause device damage or human injury.
	External grounding	This label indicates grounding of external devices. One end of the ground cable must connect to the device, and the other end to a ground point. This ensures normal running of the devices and the safety of the operator.

Label	Meaning	Description
	Internal grounding	This label indicates grounding of internal devices. The terminals of the ground cable are connected to different components of the same device. This ensures normal running of the devices and the safety of the operator.
	ESD label	This label indicates a static sensitive area. Do not touch the device with your hands. When operating the device within this area, take electrostatic discharge (ESD)-preventive measures. For example, wear an ESD wrist strap.
	Altitude	Indicates that the device operates properly at an altitude of 2000 m or lower. The symbol applies only to CCC.
	High touch current	This label indicates that the device has high touch current and must be grounded before powering it on.
	Do not touch	This label indicates hazardous moving parts. Do not touch the fans when they are rotating.
	Warning	This label indicates that at least two people are required for moving the device.
	No stacking	Do not stack after unpacking. This may cause device damage.
	No handling	Do not carry the device using its handle. This may cause injury or damage.
	Multiple inputs	This label indicates that the device has multiple power inputs. Disconnect all power inputs before you power off the device.

## 5.3 ESD Protection

## 5.3.1 Operation Instructions

To minimize ESD damage, observe the following precautions:

- Lay ESD floors or ESD cushions in the entire equipment room, and use ESD chairs. The equipment room is equipped with ESD clapboards, ESD screens, and ESD curtains.
- All floor-standing electric devices, metal frames, and metal chassis shells in the equipment room must be directly grounded. All electric meters or tools on a workbench must be connected to the common ground point of the workbench.
- Monitor the temperature and humidity in the equipment room. The heating system reduces indoor humidity and increases ESD.
- Place components in ESD bags or boxes during transportation or storage.
- Wear an ESD wrist strap when installing or removing a server component. Ensure that the ground terminal of the ESD wrist strap is inserted into the ESD jack in the chassis.
- Before touching a device, ensure that you are wearing ESD clothing and ESD gloves (or wrist strap), and remove any conductive objects (such as watches and jewelry). **Figure 5-1** shows conductive objects that must be removed before you touch a device.

**Figure 5-1** Conductive objects to be removed



- Both ends of an ESD wrist strap must be in good contact. One end contacts your bare skin, and the other is securely inserted into the ESD jack in the chassis. For details, see **5.3.2 ESD Wrist Strap**.
- During parts replacement, keep new server components in ESD bags before installation, and place removed server components on conductive mats for temporary storage.
- Do not touch welding points, pins, or exposed circuits.

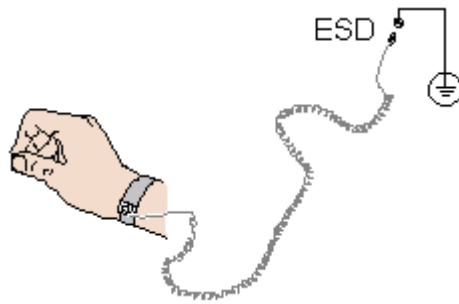
## 5.3.2 ESD Wrist Strap

A cabinet or chassis is properly grounded.

**Step 1** Put on the ESD wrist strap. See **Figure 5-2**.



**Figure 5-2** Wearing an ESD wrist strap



**Step 2** Tighten the ESD wrist strap to ensure that it is in good contact with your bare skin.

**Step 3** Insert the ground terminal of the ESD wrist strap into the ESD jack in a cabinet or chassis.

----End

## 5.4 Environmental Requirements

### NOTE

- For details about the safety precautions to be observed when you install or replace servers and their parts, see the [Huawei Server Safety Information](#).
- Suitable for mounting on concrete or other non-combustible surface only.

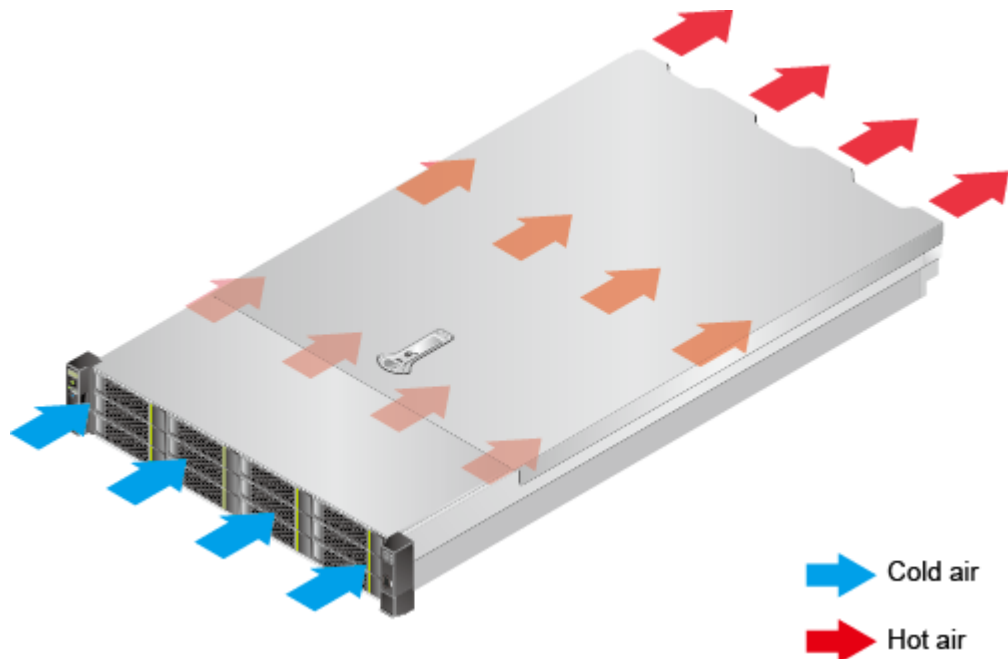
### 5.4.1 Space and Airflow Requirements

To allow for servicing and adequate airflow, observe the following space and airflow requirements:

- Install the server in an access-restricted area.
- Keep the area in which the server is located clean and tidy.
- To facilitate heat dissipation and maintenance, keep a clearance of 800 mm (31.50 in.) between walls and the front and rear doors of the cabinet.
- Do not block the air intake vents. Otherwise, air intaking and heat dissipation will be affected.
- The air conditioning system in the equipment room provides enough wind to ensure proper heat dissipation of all components.

The server draws in cool air from the front of the cabinet and exhausts hot air from the rear. Therefore, the front and rear of the cabinet must be well ventilated for optimal heat dissipation. [Figure 5-3](#) shows the direction of heat dissipation.

**Figure 5-3** Direction of heat dissipation



## 5.4.2 Temperature and Humidity Requirements

To ensure continued safe and reliable equipment operation, install or position the system in a well-ventilated, climate-controlled environment.

- Use temperature control devices all year long in any climates.
- In dry and humid areas, maintain ambient humidity within range with humidifiers and dehumidifiers respectively.

**Table 5-2** Temperature and humidity requirements in the equipment room

Item	Description
Temperature	5°C to 40°C (41°F to 104°F)
Humidity	8% RH to 90% RH (non-condensing)

## 5.4.3 Cabinet Requirements

- A standard 19-inch cabinet with a depth of more than 1000 mm (39.37 in.).
- Complies with International Electrotechnical Commission 297 (IEC 297).
- Air filters installed on cabinet doors.
- AC power supplied from the rear of the cabinet.

## 5.5 Unpacking the Chassis

**Step 1** Check that the packaging is in good condition.

 **NOTE**

If there is damage (for example, if the package is soaked or deformed, or the seals or pressure-sensitive adhesive tapes are not intact), submit the *Cargo Problem Feedback Form*.

**Step 2** Cut open the pressure-sensitive adhesive tape on the package, and open the box.

---

 **CAUTION**

Be careful with the box cutter to avoid personal injury or equipment damage.

---

**Step 3** Check the contents against [Table 5-3](#) to ensure that nothing is missing. Check that they are free from oxidation, corrosion, or damage.

**Table 5-3** Shipped items

No.	Description
1	Documentation bag that contains a warranty card, and a Quick Start Guide
2	Guide rails
3	Rack server

----End

## 5.6 Installing Optional Parts

Before installing and configuring the server, you need to install all optional parts required, for example, extra drives, and PCIe cards. For details, see [TaiShan 200 Server Maintenance and Service Guide \(Model 2280\)](#).

## 5.7 Installing the Server on Guide Rails

### 5.7.1 Installing with L-Shaped Guide Rails

L-shaped guide rails are designed for Huawei cabinets.

The servers are stackable when L-shaped guide rails are used.

**Step 1** Install the floating nuts.

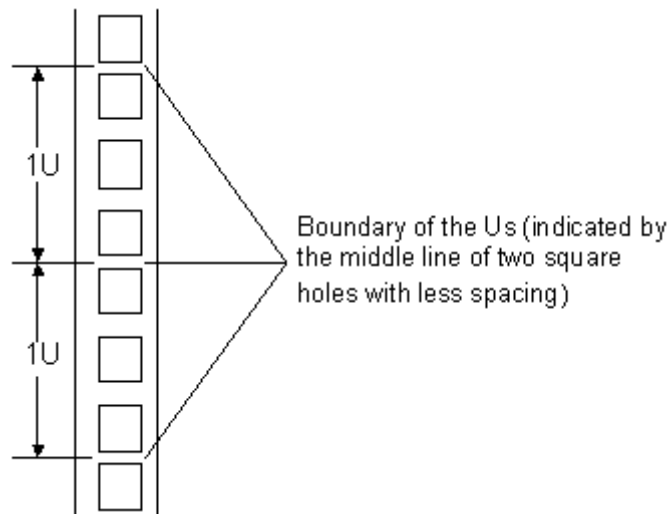
1. Determine the installation positions according to the cabinet device installation plan.

 **NOTE**

Floating nuts are used to tighten screws.

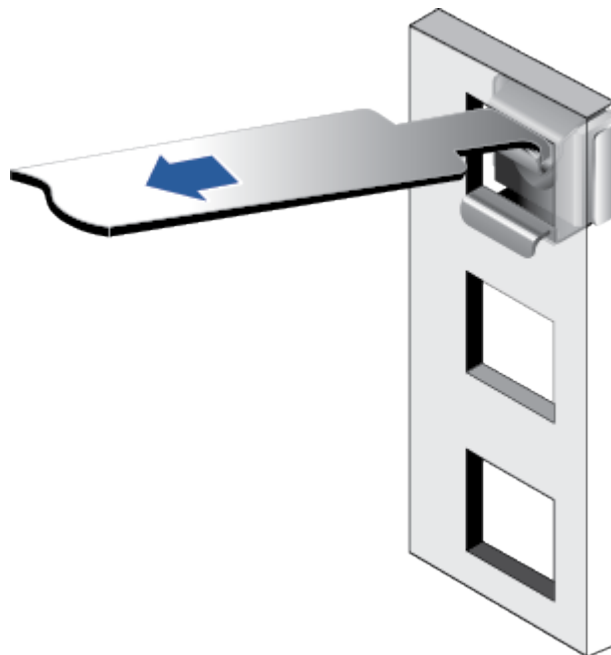
The spacing boundary is used as the reference for calculating device installation space. See [Figure 5-4](#).

**Figure 5-4** Spacing of 1U on a mounting bar of a cabinet



2. Fasten the lower end of a floating nut to the target square hole in a mounting bar at the front of the cabinet.
3. Use a floating nut hook to pull the upper end of the floating nut, and fasten it to the upper edge of the square hole. See [Figure 5-5](#).

**Figure 5-5** Installing a floating nut

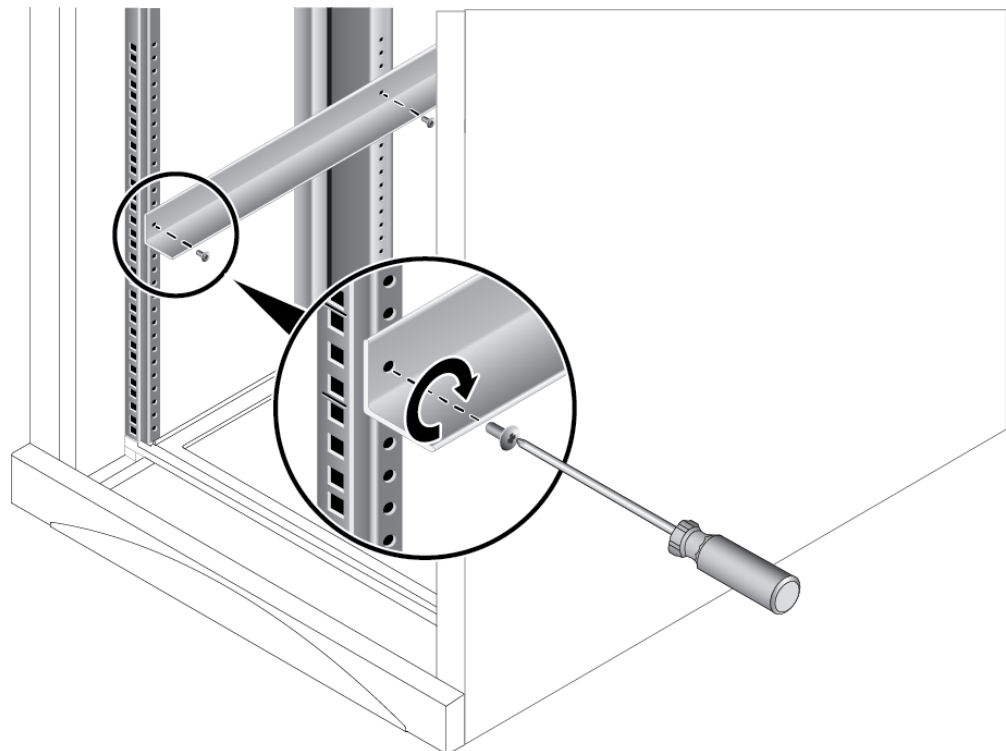


4. Install a floating nut to the other front mounting bar in the same way.

**Step 2** Install the L-shaped guide rails.

1. Position a guide rail horizontally in contact with the mounting bars in the cabinet.
2. Tighten the screws to secure the guide rail. See [Figure 5-6](#).

**Figure 5-6** Installing an L-shaped guide rail

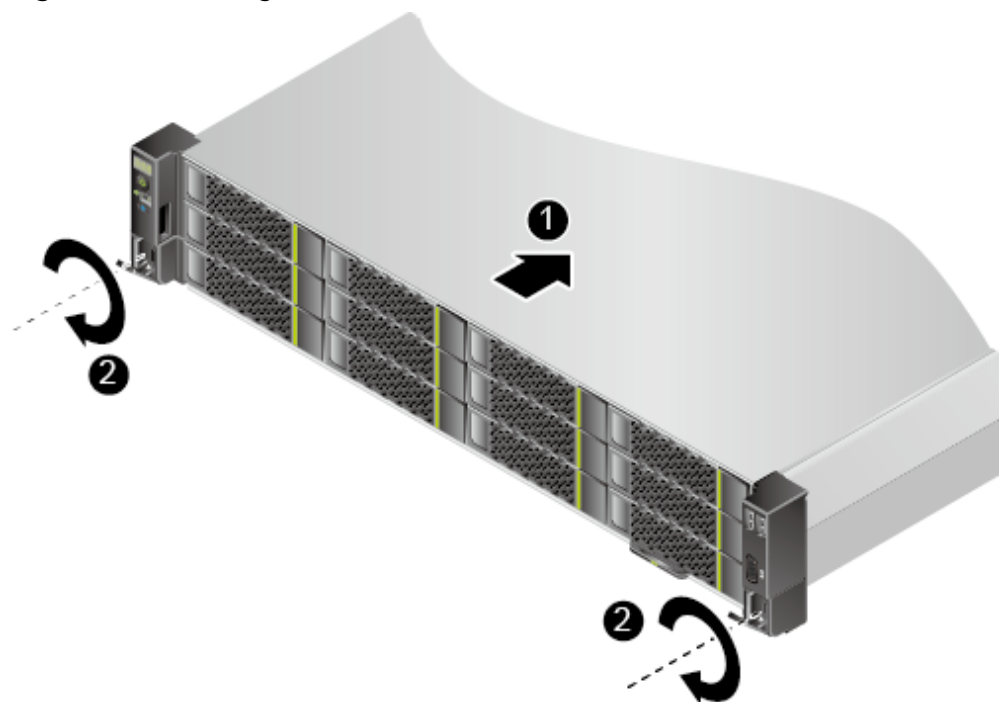


3. Install the other guide rail in the same way.

**Step 3** Install the server.

1. Lift the server. This task requires at least two people.
2. Place the server on the guide rails and slide it into the cabinet. See (1) in [Figure 5-7](#).

**Figure 5-7** Installing the server



3. When the two mounting ears of the server come into contact with the mounting bars on the cabinet, tighten their captive screws to secure the server. See (2) in [Figure 5-7](#).

**Step 4** Connect the power cables, network cables, VGA cable, and USB device as required, and power on the server.

----End

## 5.7.2 Installing with Adjustable Guide Rails

Adjustable guide rails are for a cabinet with a depth of 543.5 mm to 848.5 mm (21.40 in. to 33.41 in.) between the front and rear mounting bars.

The servers are stackable onto adjustable guide rails.

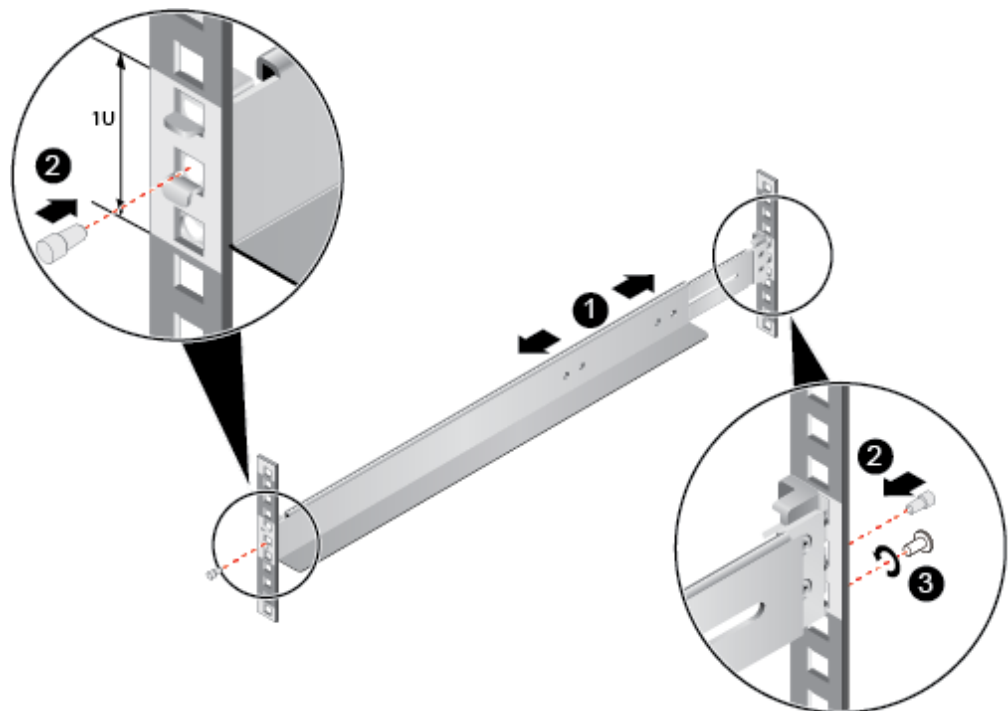
**Step 1** Install the adjustable guide rails.

1. Position a guide rail horizontally in contact with the mounting bars and hook it onto the cabinet. See (1) in [Figure 5-8](#).

### NOTE

The three holes in each mounting ear of a guide rail should be within 1U boundary lines.

**Figure 5-8** Installing an adjustable guide rail



2. Plug the second square holes at the front and rear of the guide rail using the plugs included to secure the guide rail. See (2) in [Figure 5-8](#).
3. (Optional) Install an M6 screw in the square hole underneath at the rear of the guide rail and secure it. See (3) in [Figure 5-8](#).

 **NOTE**

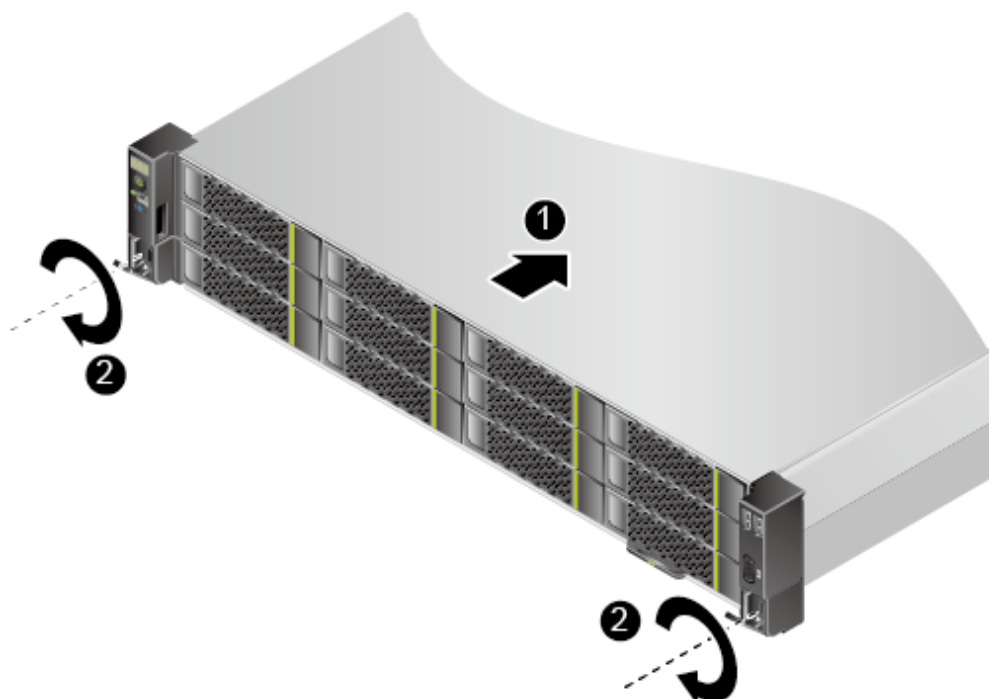
While screws are not necessary for the installation of adjustable guide rails, M6 screws at the rear end of the server will make it more shockproof and secure.

4. Install the other guide rail in the same way.

**Step 2** Install the server.

1. Lift the server. This task requires at least two people.
2. Place the server on the guide rails and slide it into the cabinet. See (1) in [Figure 5-9](#).

**Figure 5-9** Installing the server



3. When the two mounting ears of the server come into contact with the mounting bars on the cabinet, tighten their captive screws to secure the server. See (2) in [Figure 5-9](#).

**Step 3** Connect the power cables, network cables, VGA cable, and USB device as required, and power on the server.

----End

## 5.8 Connecting External Cables

## 5.8.1 Cabling Overview

### Basic Guidelines

---

**NOTICE**

To ensure optimal heat dissipation, do not block the air exhaust vents of PSUs.

---

- Lay out and bind cables of different types (such as power and signal cables) separately. Cables of the same type must be in the same direction. Route cables near each other in crossover mode. Ensure that the distance between power cables and signal cables is greater than or equal to 30 mm (1.18 in.) when you lay out the cables in parallel.
- If you cannot identify cables according to the cable labels, attach an engineering label to each cable.
- Protect cables from burrs, heat sinks, and active accessories, which may damage the insulation layers of cables.
- Ensure that the length of cable ties for binding cables is appropriate. Do not connect two or more cable ties together for binding cables. After binding cables properly, trim off the excess lengths of the cable ties and ensure that the cuts are neat and smooth.
- Ensure that cables are properly routed, supported, or fixed within the cable troughs inside the cabinet to prevent loose connections and cable damage.
- Coil any surplus lengths of cables and bind them to proper positions inside the cabinet.
- Route cables straightly and bind them neatly. The bending radius of a cable varies depending on the position where the cable is bent.
  - If you need to bend a cable in its middle, the bending radius must be at least twice the diameter of the cable.
  - If you need to bend a cable at the output terminal of a connector, the bending radius must be at least five times the cable diameter, and the cable must be bound before bending.
- Do not use cable ties at a place where the cables are bent. Otherwise, the cables may break.

### Common Methods

The methods of routing cables inside a cabinet are described as follows:

- Determine overhead cabling and underfloor cabling for power cables based on specific conditions of the equipment room. Specifically, take into consideration the AC power distribution frame (PDF), surge protector, and terminal block.
- Determine overhead cabling and underfloor cabling for service data cables based on specific conditions of the equipment room.
- Place the connectors of all service data cables at the bottom of the cabinet so that the connectors are difficult to reach.



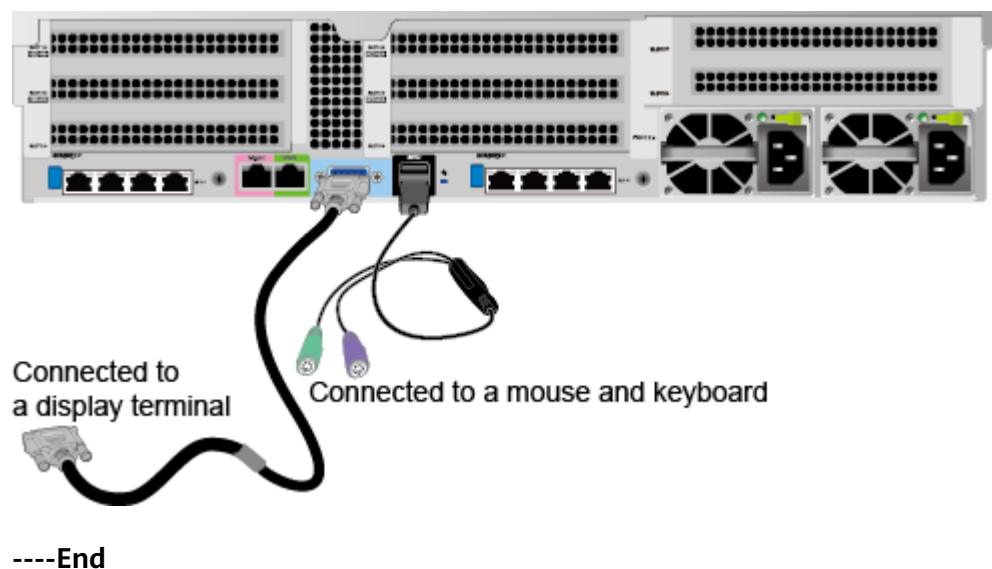
## 5.8.2 Connecting Cables to a Mouse, Keyboard, and VGA Port

The front and rear panels of the server have DB15 VGA ports but no standard PS/2 port for a keyboard or mouse.

Connect a keyboard or mouse to a USB port on the front or rear panel if needed, either directly or with a USB-to-PS/2 cable.

- Step 1** Wear an ESD wrist strap. For details, see [5.3 ESD Protection](#).
- Step 2** Plug the USB connector on the PS/2 cable into the USB port on the front or rear panel of the server.
- Step 3** Connect the connectors on the other end of the PS/2 cable to the keyboard and mouse.
- Step 4** Connect the DB15 connector on the VGA cable to the VGA port on the front or rear panel of the server and tighten the two screws.
- Step 5** Connect the other end of the VGA cable to the VGA port on the monitor and tighten the two screws.

**Figure 5-10** Connecting PS/2 and VGA cables



## 5.8.3 Connecting a Network Cable

Before connecting or replacing a network cable, use a network cable tester to check whether the new network cable is functional.

The new and old cables must be of the same model or be compatible.

Before installing a network cable to a network port, check that the network cable connector is intact and the pins have no sundries or deformation.

- Step 1** Wear an ESD wrist strap. For details, see [5.3 ESD Protection](#).
- Step 2** Check the model of the new network cable.

A shielded network cable is recommended. According to professional EMC test results, unshielded network cables provide poor ESD prevention, and the system may stop responding or restart when the static electricity is high.

**Step 3** Number the new network cable.

- The number of the new network cable must be the same as that of the old one.
- Use the same type of labels for network cables. Record the name and number of the local device on one side of a label and those of the peer device on the other side. Attach a label 2 cm (0.79 in.) away from the end of a network cable.

**Step 4** Route the new network cable in the same way (underfloor or overhead) as the network cable to be replaced.

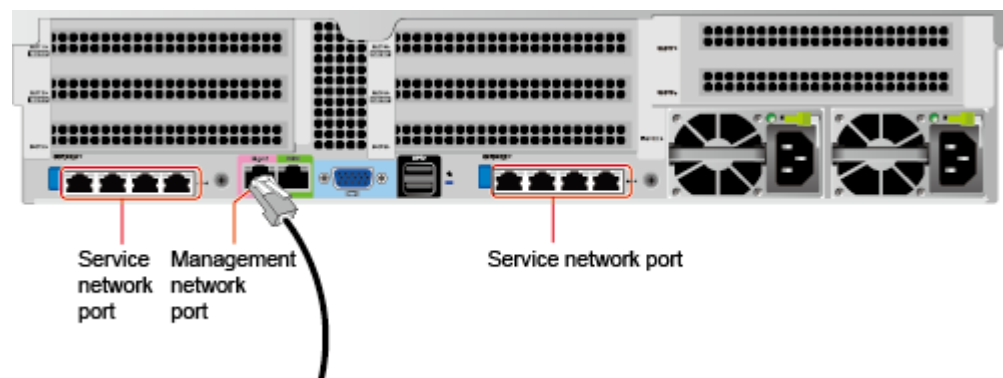
- Underfloor cabling is recommended because it is tidy and easy to route. Route cables in the cabinet based on the installation requirements. You are advised to arrange new cables in the same way as existing cables. Ensure that cables are routed neatly and undamaged.
- Separate network cables from power cables when routing.
- The minimum bend radius of a network cable is 4 cm (1.57 in.). Check that the cable insulation layer is intact. Ensure that cables are routed for easy maintenance and capacity expansion.
- Bind cables with ties when routing. Ensure that optical cables are routed straightly and bound neatly and that cable ties are installed at even spacing and fastened properly.

**Step 5** Remove the network cable to be replaced.

**Step 6** Install the new network cable.

- Connect the new network cable to the same port as the removed one.
- Install the network cable in the network port securely.

**Figure 5-11** Connecting a network cable



**Step 7** Connect the other end of the network cable to the peer network port according to the network plan.

- Connect the new network cable to the same port as the removed one.
- Install the network cable in the network port securely.

**Step 8** Check that the new network cable is functioning properly.

Power on the device, and ping the peer device connected by the new network cable. If the peer device cannot be pinged, check whether the network cable is damaged or the connectors are securely connected.

**Step 9** Bind the new network cable with other cables.

Bind the new network cable in the same way as the existing network cables. You can also remove all cable ties and bind all of the network cables again if necessary.

----End

## 5.8.4 Connecting a Cable to an Optical Port

You can connect an optical or SFP+ cable to an optical port. You need to determine the type of cable to be connected based on site requirements.

**Step 1** Wear an ESD wrist strap. For details, see [5.3 ESD Protection](#).

**Step 2** Check the model of the new network cable.

**Step 3** Number the new cable.

- The new cable must have the same number as the old one.
- Use the same type of labels for optical cables. Record the name and number of the local device to be connected on one side of a label and those of the peer device on the other side. Attach a label 2 cm (0.79 in.) away from the end of a network cable.

**Step 4** Lay out the new cable in the same way as the old one.

- Lay out optical cables or SFP+ cables in the rack based on installation regulations. You are advised to arrange cables in original mode. Ensure that cables are routed neatly and intact.
- Separate optical cables or SFP+ cables from power cables and signal cables when laying out the cables.
- Bend an optical cable or SFP+ cable with a bending radius of at least 4 cm (1.57 in.) to prevent damage to core wires. Ensure that the cable is intact. Ensure that optical cables or SFP+ cables are laid out for easy maintenance and capacity expansion.
- Bind optical cables with cable ties. Ensure that optical cables are routed straightly and bound neatly and that cable ties are installed at even spacing and fastened properly.

**Step 5** Connect the cable to an optical port.

When you use an optical cable:

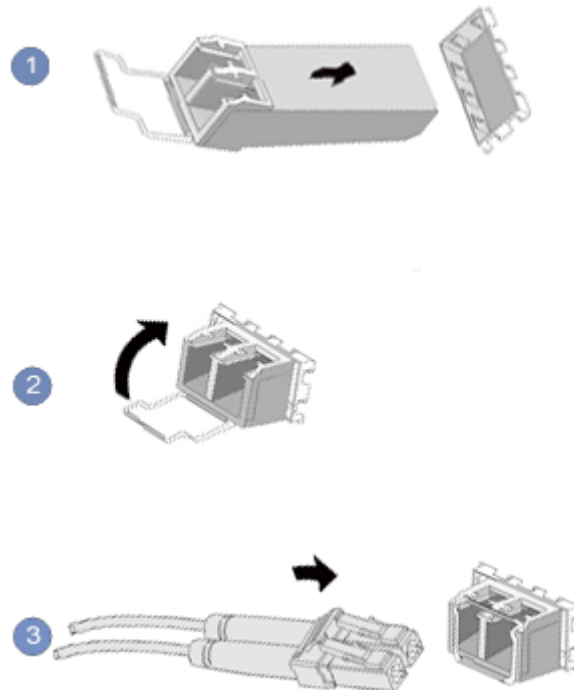
1. Remove the old optical cable from the server.
2. Connect the new optical cable.

### NOTE

- Connect the new optical cable to the same port as the old one.
  - Connect the optical cables to the optical module securely.
- a. Insert the optical module into the optical port. See (1) in [Figure 5-12](#).

- b. Close the latch on the optical module to secure it. See (2) in [Figure 5-12](#).
- c. Insert the optical cable into the optical module. See (3) in [Figure 5-12](#).

**Figure 5-12** Connecting an optical cable



When you use an SFP+ cable:

1. Remove the old SFP+ cable.  
Gently push the cable connector inwards and pull the latch out to remove the SFP+ cable. See [Figure 5-13](#).

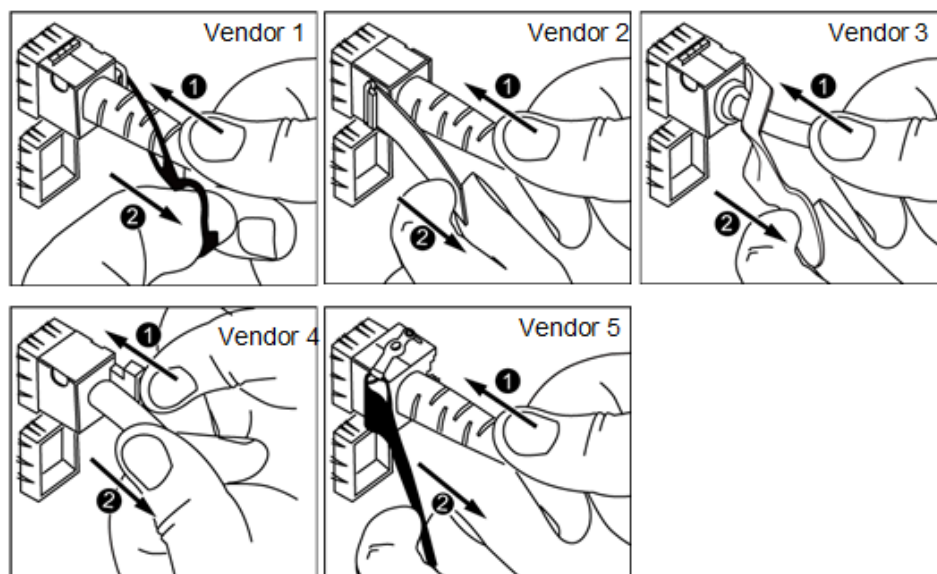
---

**NOTICE**

Do not directly pull out the latch.

---

**Figure 5-13** Removing an SFP+ cable



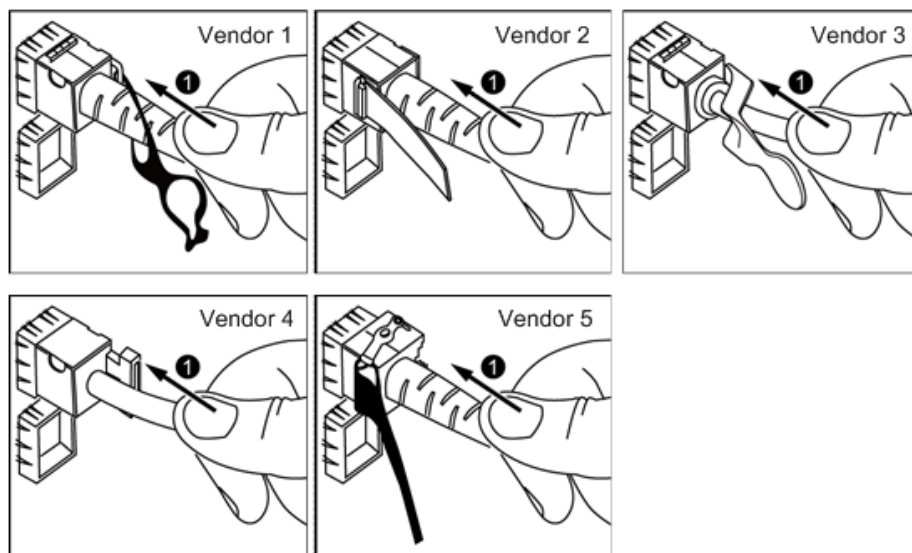
2. Connect the new SFP+ cable.

Remove the dust-proof cap on the port, and insert the cable connector into the port. See [Figure 5-14](#).

**NOTE**

When you hear a "click" sound and the cable cannot be pulled out, the connector is securely connected.

**Figure 5-14** Connecting an SFP+ cable



- Step 6** Check that the new cable is properly connected.

Power on the server, and ping the IP address of the peer device. If the peer device cannot be pinged, check whether the cable is intact or the connectors are securely connected.

- Step 7** Bind the new optical cable.

Bind the new network cable in the same way as the existing network cables. You can also remove all cable ties and bind all of the optical cables again if necessary.

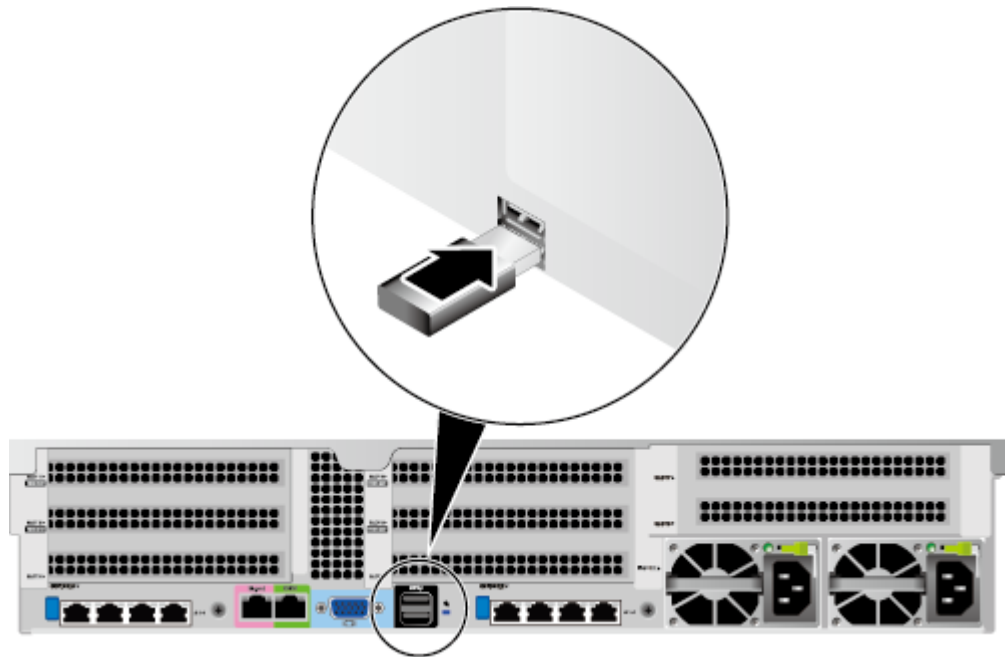
----End

## 5.8.5 Connecting a USB Device

**Step 1** Wear an ESD wrist strap. For details, see [5.3 ESD Protection](#).

**Step 2** Connect a USB device to a USB port on the server. See [Figure 5-15](#).

**Figure 5-15** Connecting a USB device



----End

## 5.8.6 Connecting a Serial Cable

The rear panel of the server provides a standard RJ45 serial port (three-pin serial port), which works as the system serial port by default. You can set it as the iBMC serial port using the iBMC CLI.

The serial port can be used as:

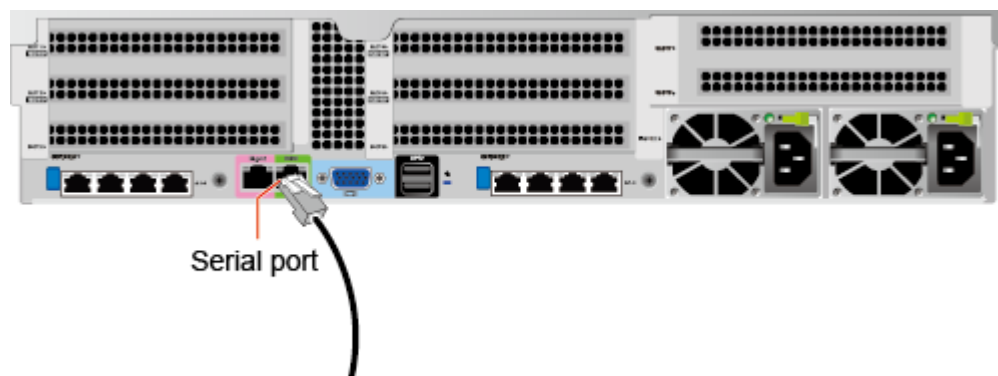
- System serial port to monitor the OS status
- iBMC serial port for debugging and fault locating

### Procedure

**Step 1** Wear an ESD wrist strap. For details, see [5.3 ESD Protection](#).

**Step 2** Plug the connector into the serial port. See [Figure 5-16](#).

**Figure 5-16** Connecting a serial cable



----End

## 5.8.7 Connecting Power Cables

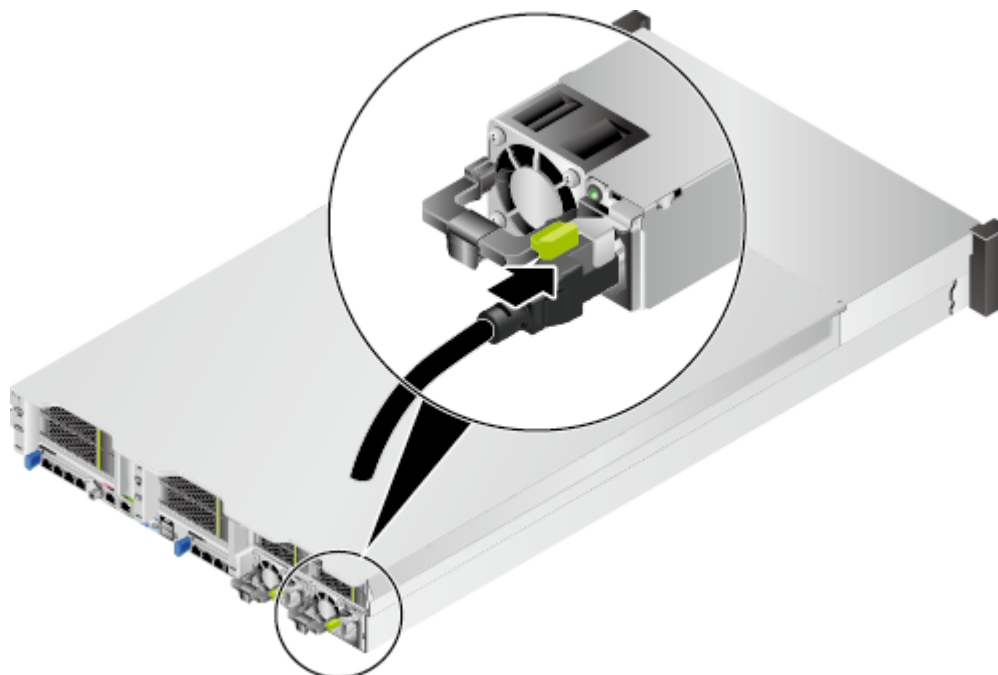
### 5.8.7.1 Connecting the AC PSU Cable

Power cables are used only for dedicated servers. Do not use them for other devices.

**Step 1** Wear an ESD wrist strap. For details, see [5.3 ESD Protection](#).

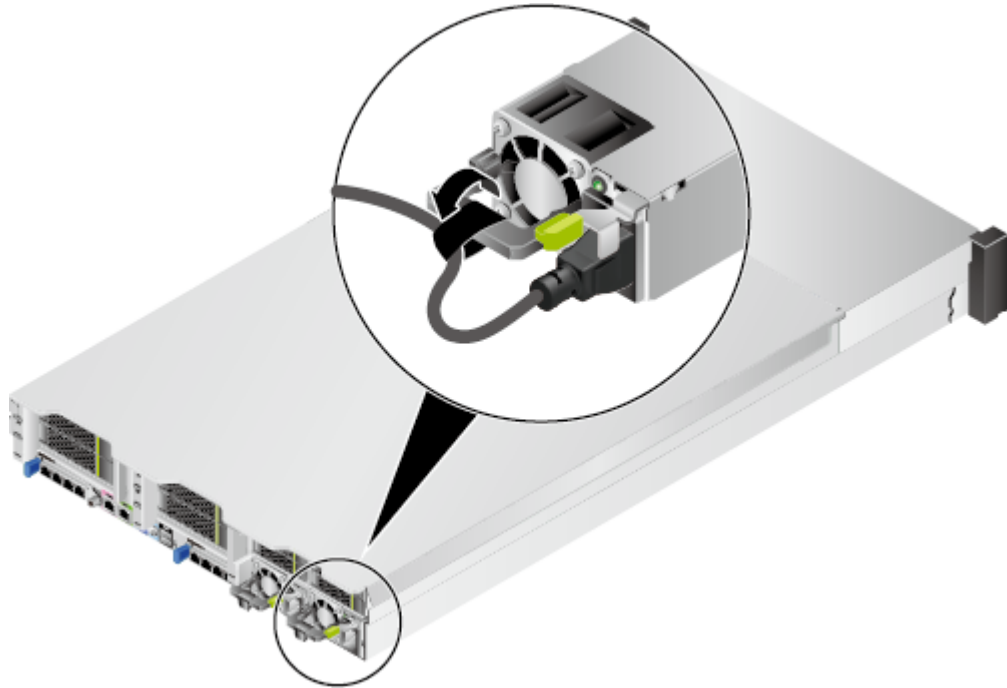
**Step 2** Connect the power cable to the PSU. See [Figure 5-17](#).

**Figure 5-17** Connecting a power cable



**Step 3** Secure the power cable using a velcro strap. See [Figure 5-18](#).

**Figure 5-18** Securing a power cable



**Step 4** Insert the other end of the power cable into the AC power socket on the cabinet. The AC power socket is located horizontally at the rear of the cabinet. Select a jack on the power socket for connection.

**Step 5** Bind the power cable to the CMA using cable ties.

----End

### 5.8.7.2 Connecting DC PSU Cables

#### NOTICE

- Use dedicated power cables to ensure equipment and personal safety.
- Use power cables only for dedicated servers. Do not use them for other devices.
- Connect the power cables of the active and standby PSUs to different power distribution units (PDUs) to ensure reliable system operation.
- Ground the equipment before powering it on.

#### Procedure

**Step 1** Wear an ESD wrist strap. For details, see [5.3 ESD Protection](#).

**Step 2** Take the spare part out of its ESD bag.

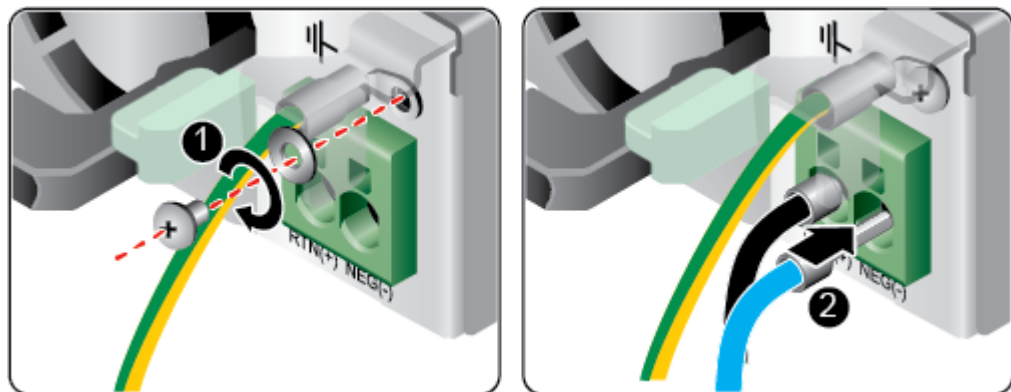
**Step 3** Connect the power cables to the PSUs.

1. Put the OT terminal (for the ground cable) on the screw removed from the ground hole, install the screw on the ground hole, and tighten the screw. See (1) in [Figure 5-19](#).



2. Insert the power cables to the wiring terminals on the PSU until the cables click into position. See (2) in [Figure 5-19](#).
  - Connect the cord end terminal of the negative power cable (blue) to the NEG(-) wiring terminal on the PSU.
  - Connect the cord end terminal of the positive power cable (black) to the RTN(+) wiring terminal on the PSU.

**Figure 5-19** Connecting cables



**Step 4** Connect the other end of the power cable to the DC PDU in the cabinet.

The DC PDU is fastened horizontally in the rear of the cabinet. Connect the power cable to the socket on the PDU according to the plan.

**Step 5** Bundle the power cables to the cable guide using cable ties.

----End

## 5.8.8 Verifying Cable Connections

### CAUTION

Before verifying cable connections, check that the power is cut off. Otherwise, any incorrect connection or loose connection may cause human injury or device damage.

Check cable connections against [Table 5-4](#).

**Table 5-4** Cable connection checklist

Item	Description
Power cable	Power cables are correctly connected to the rear of the chassis.
Network cable	Network cables are connected correctly to the management network port or service ports on the rear panel of the chassis.

Item	Description
Ground cable	The 2280 does not provide a separate ground port. It is grounded through the ground cable of a power cable. Ensure that the power cables of the PSUs are in good contact.

## 5.9 Powering On and Off the Server



### Powering On the Server

Power on the server using one of the following methods based on the actual situation:

- If the PSUs are properly installed but are not connected to an external power supply:  
Connect the external power supply to the PSUs. Then the server will power on with the PSUs.

#### NOTE

The default value of **System State Upon Power Supply** is **Power on**, which indicates that the server automatically powers on after power is supplied to the PSUs. To change the value of **System State Upon Power Supply**, log in to the iBMC WebUI and choose **Power > Power Control**.

- If the PSUs are properly installed and connected to the external power supply and the server is in the standby state (the power indicator is steady yellow), power on the server as follows:
  - Press the power button on the front panel to power on the server. For details about the power button position, see [2.2 Front Panel Indicators and Buttons](#).
  - Power on the server using the iBMC WebUI.
    - i. Log in to the iBMC WebUI. For details, see [5.10.4 Logging In to the iBMC WebUI](#).
    - ii. Open the **Power Control** page.
      - If the iBMC version is earlier than V500, choose **Power > Power Control**.
      - If the iBMC version is V500 or later, choose **System > Power > Power Control**.
    - iii. Click **Power On**. In the displayed dialog box, click **Yes** to power on the server.
  - Power on the server using the Remote Virtual Console.
    - i. Log in to the Remote Virtual Console. For details, see [8.1 Logging In to the Remote Virtual Console](#).
    - ii. On the KVM screen, click  or  on the menu bar.
    - iii. Choose **Power On**.  
A dialog box is displayed.

- iv. Click **Yes** to power on the server.
- Power on the server using the iBMC CLI.
  - i. Log in to the iBMC CLI. For details, see [8.2 Logging In to the iBMC CLI](#).
  - ii. On the iBMC CLI, run the **ipmcset -d powerstate -v 1** command.
  - iii. Enter **y** or **Y** to power on the server.

## Powering Off the Server

### NOTE

- Services and programs running on the server will be interrupted when it is powered off. Before powering off the server, ensure that all services and programs have been stopped or switched to other servers.
- Power-off in this section indicates to power off the server to the standby state (the power indicator is steady yellow).
- After the server is forcibly powered off, wait for more than 10s to ensure that the server is powered off completely. Then you can power it on again.

Power off the server using one of the following methods:

- Use cables to connect the server to a video display, keyboard, and mouse, and shut down the server OS to power off the server.
- Press the power button on the front panel to power off the server. For details about the power button position, see [2.2 Front Panel Indicators and Buttons](#).
  - When the server is powered on, press the power button to shut down the OS to power off the server.

### NOTE

If the server OS is running, shut it down as prompted.

- When the server is powered on, hold down the power button for 6 seconds to forcibly power off the server.

---

### NOTICE



A forced power-off may cause data loss or program damage. Forcibly power off the server only when necessary.

---

- Power off the server using the iBMC WebUI.
  - a. Log in to the iBMC WebUI. For details, see [5.10.4 Logging In to the iBMC WebUI](#).
  - b. Open the **Power Control** page.
    - If the iBMC version is earlier than V500, choose **Power > Power Control**.
    - If the iBMC version is V500 or later, choose **System > Power > Power Control**.
  - c. Click **Power Off** or **Forced Power Off**. In the displayed dialog box, click **Yes** to power off the server.

**NOTICE**

A forced power-off may cause data loss or program damage. Forcibly power off the server only when necessary.

- Power off the server using the Remote Virtual Console.
  - a. Log in to the Remote Virtual Console. For details, see [8.1 Logging In to the Remote Virtual Console](#).
  - b. On the KVM screen, click  or  on the menu bar.
  - c. Choose **Power Off** or **Forced Power Off**.  
A dialog box is displayed.

**NOTICE**

A forced power-off may cause data loss or program damage. Forcibly power off the server only when necessary.

- d. Click **Yes** to power off the server.
- Power off the server using the iBMC CLI.
  - a. Log in to the iBMC CLI. For details, see [8.2 Logging In to the iBMC CLI](#).
  - b. On the iBMC CLI, run the `ipmcset -d powerstate -v 0` command to power off the server or the `ipmcset -d powerstate -v 2` command to forcibly power it off.

**NOTICE**

A forced power-off may cause data loss or program damage. Forcibly power off the server only when necessary.

- c. Enter **y** or **Y** to power off the server.

## 5.10 Initial Configuration

### 5.10.1 Default Data

[Table 5-5](#) lists the default data for configuring the server.

**Table 5-5** Default data

Item	Name	Default Value
iBMC management network port data	IP address and subnet masks	<ul style="list-style-type: none"> <li>• IP address: 192.168.2.100</li> <li>• Subnet mask: 255.255.255.0</li> </ul>

Item	Name	Default Value
iBMC login data	User name and password	<ul style="list-style-type: none"> <li>User name: Administrator</li> <li>Password: Admin@9000</li> </ul>
BIOS data	Password	Admin@9000
iBMC U-Boot data	Password	Admin@9000

## 5.10.2 Configuration Process

Figure 5-20 shows the initial configuration process of the server.

Figure 5-20 Initial configuration process

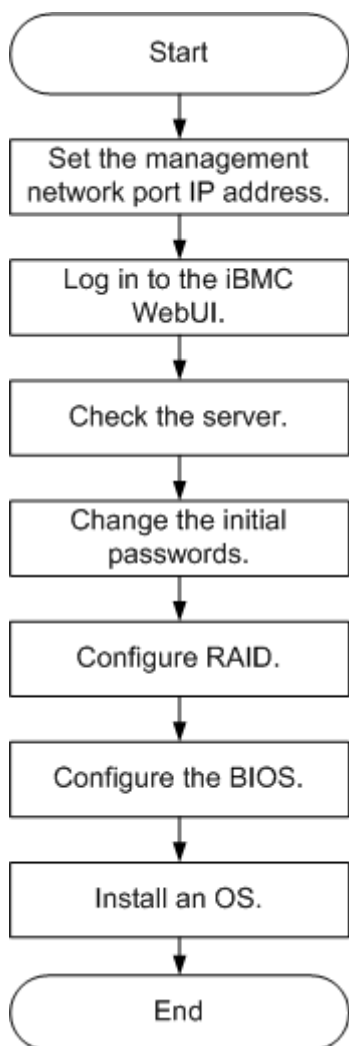


Table 5-6 describes the initial configuration process.

**Table 5-6** Configuration process

Step	Action
Set the management network port IP address.	Set an IP address for the management network port.
Log in to the iBMC WebUI.	Log in to the iBMC WebUI from a local PC.
Check the server.	<ul style="list-style-type: none"> <li>• Check that the server version information is correct.</li> <li>• Check that no alarm is generated for the server.</li> </ul>
Change the initial passwords.	<ul style="list-style-type: none"> <li>• Change the iBMC user name and password for the server.</li> <li>• Change the U-Boot password.</li> </ul>
Configure RAID.	Configure RAID for the server. For details, see the <a href="#">RAID Controller Card User Guide (Kunpeng Processors)</a> .
Configure the BIOS.	Configure the server BIOS, including setting the boot option priority and BIOS password.
Install an OS.	Install an OS for the server.

### 5.10.3 Querying the Management Network Port IP Address

#### Methods

You can obtain the IP address using any of the following methods:

- Obtain the default IP address.
- Use the iBMC WebUI.
- Use the BIOS. For details, see this topic.
- Log in to the iBMC CLI through the serial port, and run the `ipmcget -d ipinfo` to query the IP address of the management network port. For details, see [TaiShan Rack Server iBMC User Guide](#).

#### Default IP Address

The default IP address of the iBMC management network port is 192.168.2.100.

#### Procedure

- Step 1** Connect a USB mouse and keyboard.
- Step 2** Connect a monitor via VGA cable.
- Step 3** Restart the OS.



Figure 5-22 IBMC Config screen 1

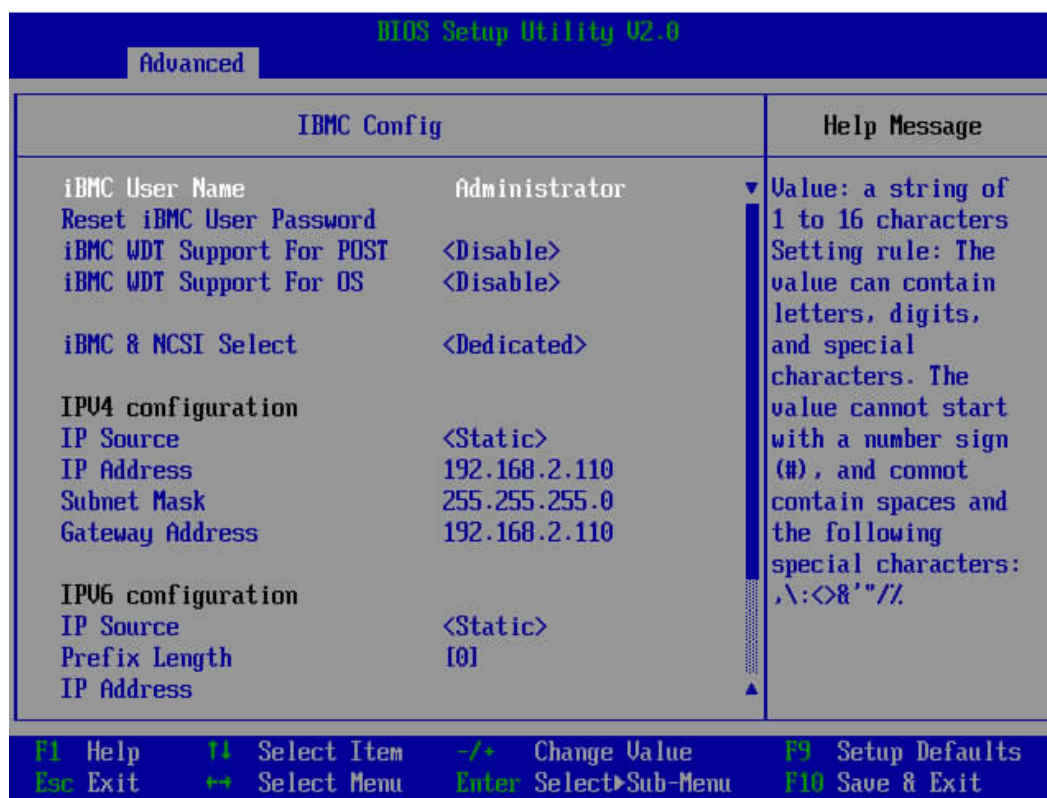
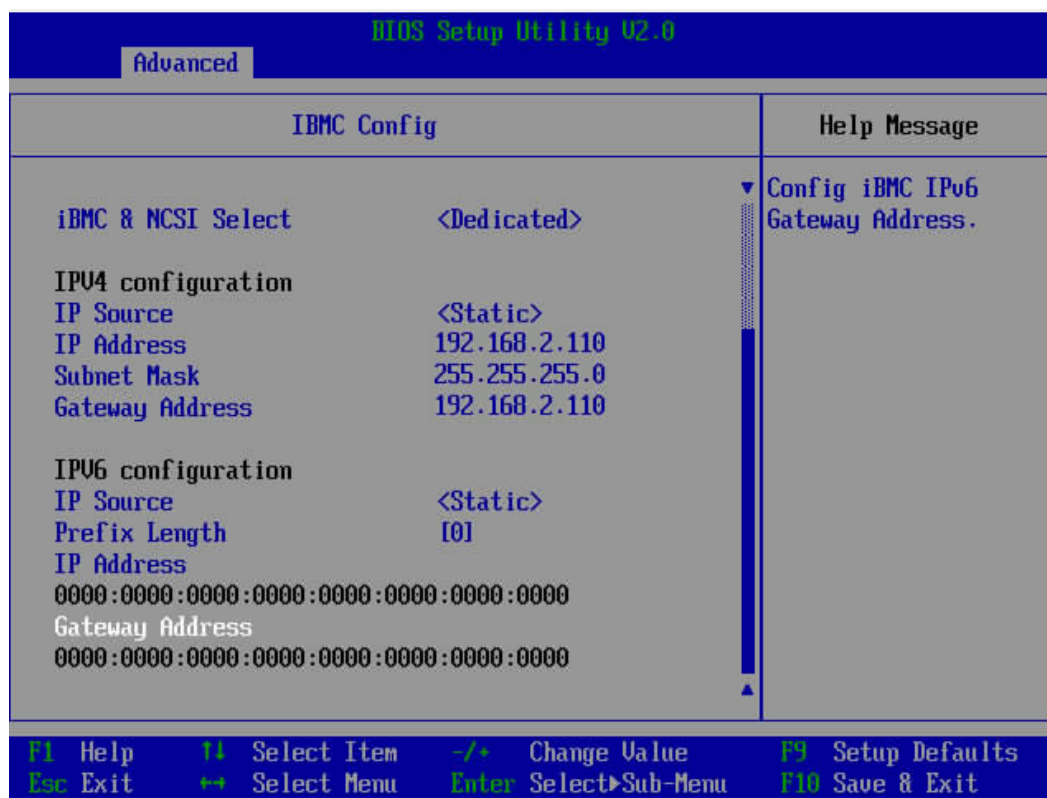


Figure 5-23 IBMC Config screen 2



----End



## 5.10.4 Logging In to the iBMC WebUI

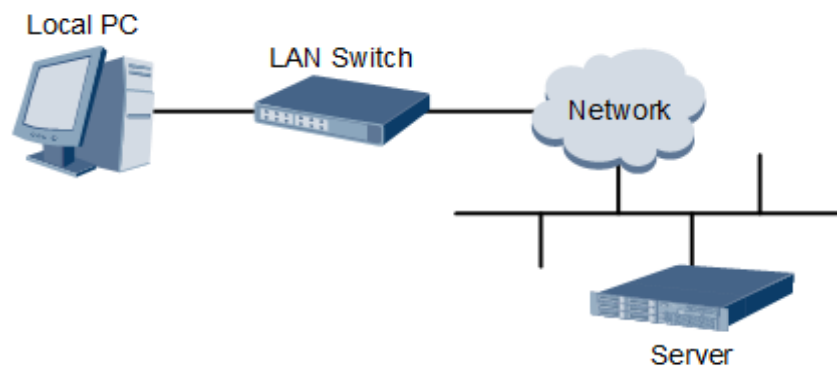
Log in to the iBMC WebUI by using a browser on the local PC, illustrated here running Windows 7 and Internet Explorer 11.0.

For details about PC system configuration requirements, see the [TaiShan Rack Server iBMC User Guide](#).

- Step 1** Connect the local PC to the iBMC management network port on the server using a crossover cable or twisted pair cable.

**Figure 5-24** shows the network diagram.

**Figure 5-24** Network diagram



- Step 2** Open Internet Explorer on the local PC.

- Step 3** In the address box, enter the iBMC address in the format:

`https://IP address of the iBMC management network port on the server`

Example: `https://192.168.2.100`

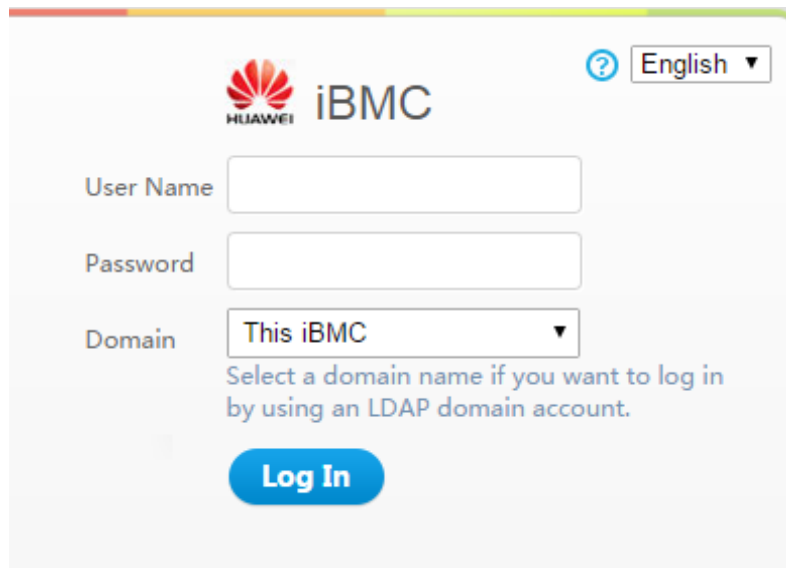
- Step 4** Press **Enter**.

The iBMC login page is displayed, as shown in [Figure 5-25](#) and [Figure 5-26](#).

### NOTE

- If the message "There is a problem with this website's security certificate" is displayed, click **Continue to this website (not recommended)**.
- If the system displays the **Security Alert** dialog box indicating a certificate error, click **Yes**.

**Figure 5-25** iBMC login page (earlier than V500)



The screenshot displays the iBMC login interface. At the top left is the Huawei logo and the text "iBMC". To the right is a language selector showing "English" with a dropdown arrow. Below the header are three input fields: "User Name", "Password", and "Domain". The "Domain" dropdown menu is currently set to "This iBMC". Below the "Domain" field is a note: "Select a domain name if you want to log in by using an LDAP domain account." At the bottom center is a blue "Log In" button.

**Figure 5-26** iBMC login page (V500 or later)



The screenshot shows the iBMC login interface. At the top left is the 'iBMC' logo. To its right is a grey rectangular area with a diagonal grid pattern. Further right is a QR code. Below the logo is the 'User Name' label and a text input field with the placeholder 'Please enter the user name.'. Below that is the 'Password' label and a text input field with the placeholder 'Please enter the password.'. Below the password field is the 'Domain' label and a dropdown menu currently showing 'Local iBMC'. At the bottom center is a large blue button labeled 'Log In'. Below the button is a link labeled 'SSO'.

**Step 5** On the login page, enter the user name and password.

The default user name is **Administrator**, and the default password is **Admin@9000**.

**NOTE**

If the account is locked due to five consecutive failed attempts, try again in 5 minutes.

**Step 6** Select **This iBMC** from the **Domain** drop-down list.

**Step 7** Click **Log In**.

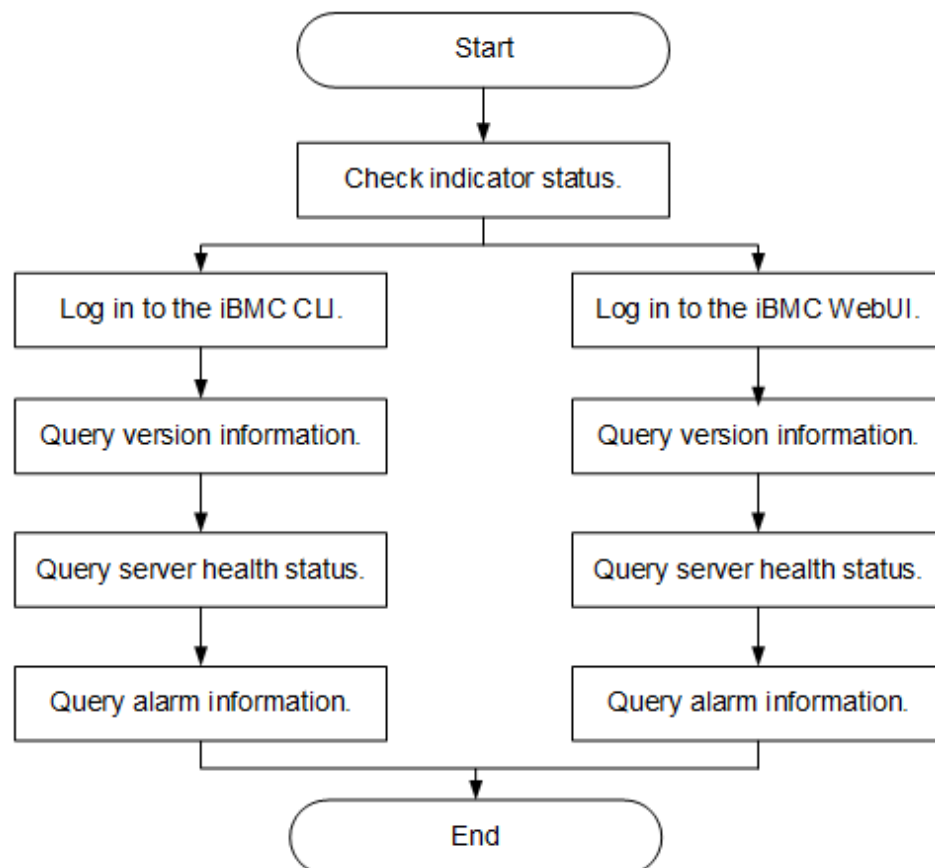
----End

## 5.10.5 Checking the Server

Check the server in the sequence shown in [Figure 5-27](#). The method to be used depends on the actual situation.

For details about CLI commands, see the [TaiShan Rack Server iBMC User Guide](#).

**Figure 5-27** Checking the server



### Procedure

**Step 1** Check indicator status.

Ensure that hardware devices are working correctly.

For details, see [2.2 Front Panel Indicators and Buttons](#) and [2.4 Rear Panel Indicators](#).

**Step 2** Check the server.

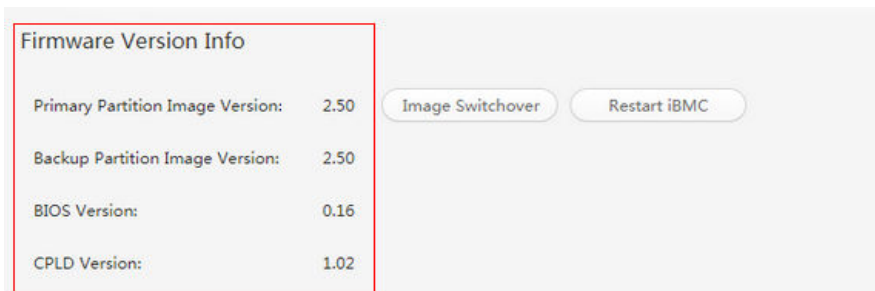
- Check the server using the iBMC WebUI.
  - a. Log in to the iBMC over the WebUI. For details, see [5.10.4 Logging In to the iBMC WebUI](#).

**NOTE**

You are advised to change the initial password when logging in to the iBMC for the first time. For details, see [5.10.6 Changing Initial Passwords](#).

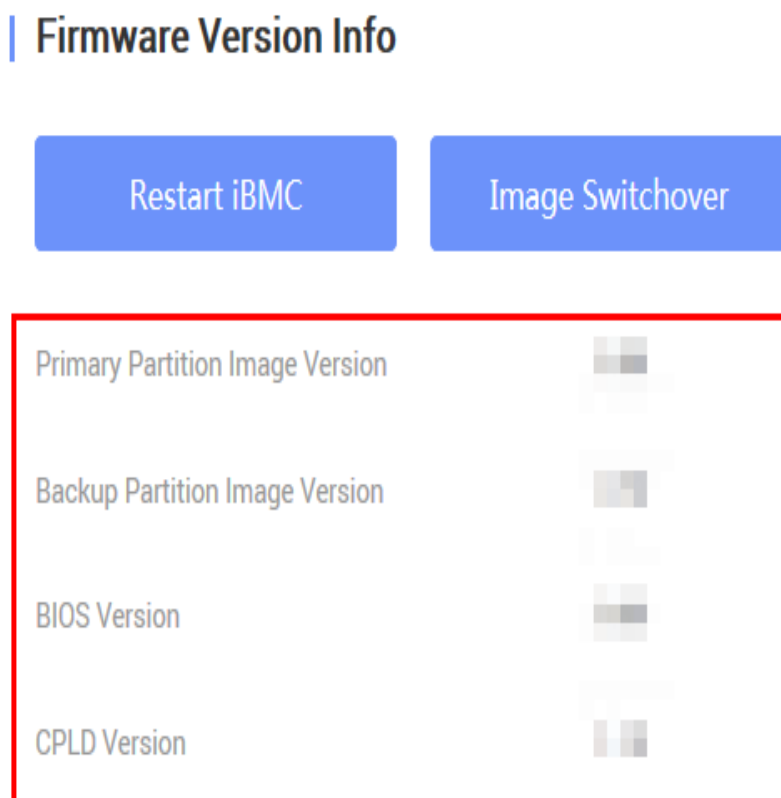
- b. Check the server firmware version.
  - If the iBMC version is earlier than V500, choose **System > Firmware Upgrade**. The page shown in **Figure 5-28** is displayed.

**Figure 5-28** Querying firmware information (earlier than iBMC V500)



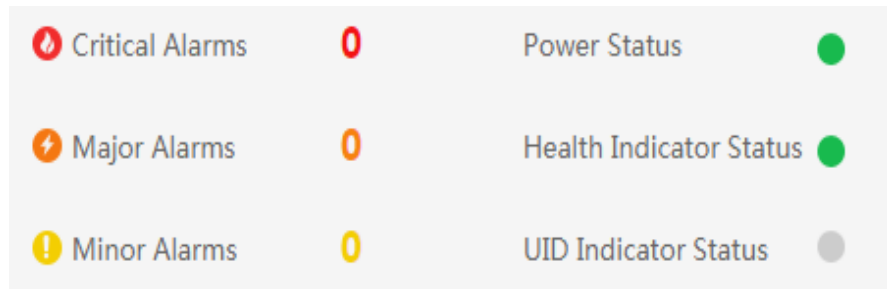
- If the iBMC version is V500 or later, choose **iBMC Settings > Firmware Upgrade**. The page shown in **Figure 5-29** is displayed.

**Figure 5-29** Querying firmware information (iBMC V500 or later)



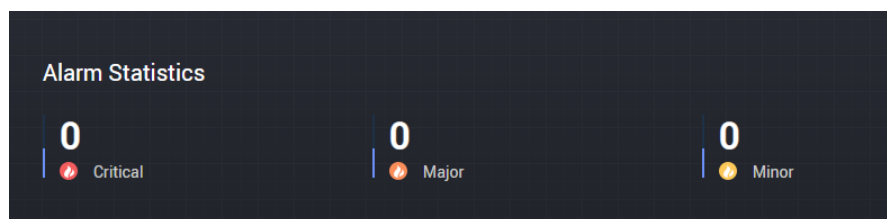
- c. Check the health status of the server.
  - If the iBMC version is earlier than V500, choose **Information > Overview**. The page shown in **Figure 5-30** is displayed.

**Figure 5-30** Querying alarm information (earlier than iBMC V500)



- If the iBMC version is V500 or later, view **Alarm Statistics** on the **Home** page, as shown in [Figure 5-31](#).

**Figure 5-31** Querying alarm information (iBMC V500 or later)



- d. Clear any alarms if present. For details, see the [TaiShan Rack Server iBMC Alarm Handling](#).
- Check the server using the iBMC CLI.
    - a. Set an IP address for the PC. This IP address must be on the same network segment as the iBMC management network port.
    - b. Connect a network cable from the PC to the iBMC management network port of the server.
    - c. Start a Secure Shell (SSH, PuTTY), tool on the PC and log in with the IP address of the iBMC management network port and iBMC user name and password.

**NOTE**

By default, SSH is used to log in to the iBMC. If the SSH service is disabled, enable it by choosing **Configuration > Services** on the iBMC WebUI.

- d. Run the **ipmcget -d ver** command to view the server version information. Check that the server versions meet site requirements.

```
iBMC:~>ipmcget -d ver
----- iBMC INFO -----
IPMC CPU: Hi1710
IPMI Version: 2.0
CPLD Version: (U6076)1.00
Active iBMC Version: (U68)3.32
Active iBMC Build: 003
Active iBMC Built: 14:32:33 Apr 15 2019
Backup iBMC Version: 3.32
SDK Version: 3.26
SDK Built: 10:53:30 Mar 18 2019
Active Uboot Version: 2.1.13 (Dec 24 2018 - 20:23:20)
Backup Uboot Version: 2.1.13 (Dec 24 2018 - 20:23:20)
----- Product INFO -----
Product ID: 0x0001
Product Name: TaiShan 200 (Model 5280)
```

```
iME Version: 0.66
BIOS Version: (U75)0.90
----- Mother Board INFO -----
Mainboard BoardID: 0x00b9
Mainboard PCB: .A
----- Riser Card INFO -----
Riser1 BoardName: BC11PRUCRiser1
BoardID: 0x0090
Riser1 PCB: .A
Riser2 BoardName: BC82PRNE
Riser2 BoardID: 0x0032
Riser2 PCB: .A
----- HDD Backplane INFO -----
Disk BP1 BoardName: BC11THBQ
Disk BP1 BoardID: 0x0073
Disk BP1 PCB: .A
Disk BP1 CPLD Version:(U3)1.10
----- IO Board INFO -----
IOBoard5 ProductName: BC82IOBA
IOBoard5 BoardID: 0x0069
IOBoard5 PCB: .A
IOBoard5 CPLD Version: (U12)0.01
```

- **CPLD Version:** complex programmable logical device (CPLD) version of the server
  - **BIOS Version:** BIOS version of the server
  - **Active iBMC Version:** active iBMC version of the server
  - **Backup iBMC Version:** backup iBMC version of the server
- e. Query the health status of the server.
- ```
iBMC:/->ipmcget -d health
System in health state
```
- If "System in health state" is displayed, no further action is required.
  - If alarm information is displayed, go to the next step.
- f. Query any generated alarms.
- ```
iBMC / # ipmcget -d healthevents
```
- | Event Num | Event Time          | Alarm Level | Event Code | Event Description   |
|-----------|---------------------|-------------|------------|---|
| 1         | 2019-02-10 00:52:23 | Minor       | 0x12000021 | get description failed.   |
| 2         | 2019-02-10 01:37:42 | Minor       | 0x12000013 | Failed to obtain data of the air inlet temperature.                     |
| 3         | 2019-02-10 00:52:23 | Minor       | 0x12000019 | Right mounting ear is not present.                                      |
| 4         | 2019-02-10 00:52:19 | Major       | 0x28000001 | The SAS or PCIe cable to front disk backplane is incorrectly connected. |
- g. Clear alarms. For details, see the [TaiShan Rack Server iBMC Alarm Handling](#).

----End

## 5.10.6 Changing Initial Passwords

Change the following initial user passwords:

- Initial password of the default iBMC user
- Initial password for the iBMC U-Boot

 **NOTE**

- The default iBMC user account is **Administrator**.
- U-Boot is a piece of underlying software used to configure basic settings, for example, initializing hardware devices and setting up memory space mapping, to prepare for commissioning the OS.
- To ensure system security, change your initial password at your first login and change the password periodically.
- A simple password is easy to crack, which makes the system vulnerable. You are advised to use a password that meets complexity requirements or to enable the password complexity check function.
- The password complexity check function is enabled by default.

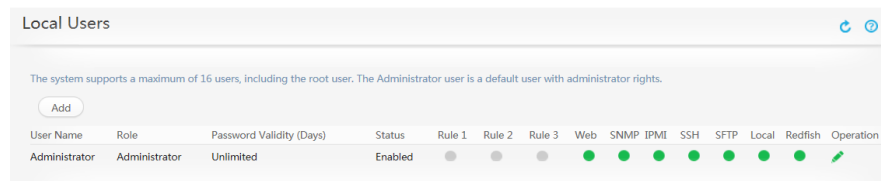
You can change an iBMC user password on the iBMC WebUI or CLI. The following describes how to change a user password on the iBMC WebUI. For details about operations on the iBMC CLI, see the [TaiShan Rack Server iBMC User Guide](#).

## Changing the Initial Password of the Default iBMC User

**Step 1** Log in to the iBMC WebUI and open the **Local User** page.

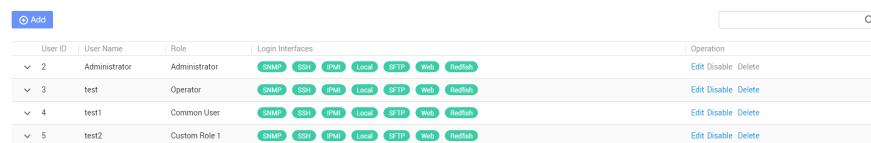
- If the iBMC version is earlier than V500, choose **Configuration > Local Users**. The page shown in [Figure 5-32](#) is displayed.

**Figure 5-32** Local Users page (earlier than iBMC V500)




- If the iBMC version is V500 or later, choose **User & Security > Local Users**. The page shown in [Figure 5-33](#) is displayed.

**Figure 5-33** Local Users page (iBMC V500 or later)



**Step 2** Modify user information.

- If the iBMC version is earlier than V500, locate the user and click . The page shown in [Figure 5-34](#) is displayed.



**Figure 5-34** Modifying user information (earlier than iBMC V500)

- If the iBMC version is V500 or later, locate the user and click **Edit**. The page shown in [Figure 5-35](#) is displayed.

**Figure 5-35** Modifying user information (iBMC V500 or later)

**Step 3** Change the user password by following on-screen instructions.

The password must meet the following complexity requirements:

- Contain 8 to 20 characters.

- Contain at least one space or one of the following special characters:  
`~!@#%&\*()-\_+=\|[{]};:'",<.>/?`
- Contain at least two types of the following characters:
  - Lowercase letters a to z
  - Uppercase letters A to Z
  - Digits 0 to 9
- Cannot be the same as the user name or user name in reverse order.

----End

## Changing the Initial iBMC U-Boot Password

**Step 1** Log in to the iBMC CLI over the serial port.

**Step 2** Run the following command to restart the iBMC:

```
iBMC:/->ipmcset -d reset
```

The command output is as follows:

```
This operation will reboot IPMC system. Continue? [Y/N]:
```

**Step 3** Enter **y**.

The system restarts.

**Step 4** Press **Ctrl+B** immediately when the system displays the message

```
Hit 'ctrl + b' to stop autoboot: 1
```

**Step 5** Enter the default password for the iBMC U-Boot.

The following prompt indicates that you have logged in to the U-Boot.

```
u-boot>
```

**Step 6** Run the following command to change the U-Boot password:

```
u-boot> passwd
```

The following information is displayed:

```
Enter old password:
```

**Step 7** Enter the old password.

### NOTE

The default password is **Admin@9000**.

The following information is displayed:

```
Enter new password:
```

**Step 8** Enter a new password.

The following information is displayed:

```
Enter the new password again:
```

**Step 9** Enter the new password again.

If the command output is as follows, the password has been changed:

```
. done
Un-Protected 1 sectors
Erasing Flash...
. done
Erased 1 sectors
Writing to Flash... done
. done
Protected 1 sectors

password be changed successfully.
```

**Step 10** Run the following command to exit U-Boot:

```
boot

----End
```

## 5.10.7 Configuring RAID

**Step 1** Log in to the iBMC WebUI. For details, see [5.10.4 Logging In to the iBMC WebUI](#).

**Step 2** Query RAID controller card information.

- If the iBMC version is earlier than V500, choose **Information > System Info > Other Devices**. The page shown in [Figure 5-36](#) is displayed.

**Figure 5-36** RAID controller card information (earlier than iBMC V500)

Name	Location	Manufactur...	ID	Type	PCB Version	CPLD Versi...	Board ID	Connected ...	BOM Code
SR450C-M 2G	mainboard	Huawei	1	LSI SAS3508	.B	0.02	0x002a	CPU1	03024.IMY

- If the iBMC version is V500 or later, choose **System > Storage Management**. The page shown in [Figure 5-37](#) is displayed.

**Figure 5-37** RAID controller card information (iBMC V500 or later)

Controller Information	
Name	Type
N/A	LSI SAS3408
Firmware Version	Out-of-Band Management Supported
N/A	No

### NOTE

The information shown in [Figure 5-37](#) is for reference only. The actual information may differ.

**Step 3** Configure a RAID array.

The RAID configuration method varies according to the RAID controller card model. For details, see the [RAID Controller Card User Guide \(Kunpeng Processors\)](#).

----End

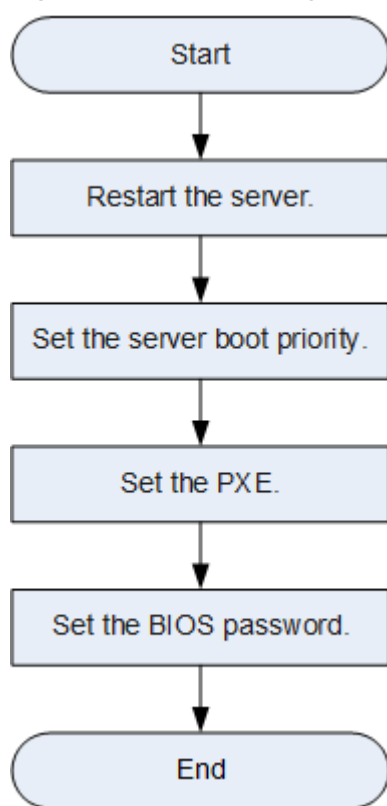
## 5.10.8 Configuring the BIOS

[Figure 5-38](#) shows the process for configuring the BIOS.

### NOTE

For details, see the [BIOS Parameter Reference \(Kunpeng 920 Processor\)](#).

**Figure 5-38** BIOS configuration process



### Restart the server

**Step 1** Log in to the Remote Virtual Console. For details, see [8.1 Logging In to the Remote Virtual Console](#).

**Step 2** On the Remote Virtual Console, click  or  on the menu bar.

**Step 3** Select **Forced System Reset**.

The system displays "Are you sure to perform this operation?"

**Step 4** Click **Yes**.

The server restarts.



Figure 5-40 Boot screen



**Step 2** Select **Boot Type Order** and press **Enter**.

The **Boot Type Order** screen is displayed.

**NOTE**

The default boot sequence is **Hard Disk Drive > CD or DVD-ROM Drive > PXE > Others**.

**Step 3** Select a boot option and press "+" or "-" to change the boot order.

- Press "+" to move a boot option up.
- Press "-" to move a boot option down.

**NOTE**

The server will boot in the order displayed.

**Step 4** Press **F10**.

The **Save Configuration&Exit** dialog box is displayed.

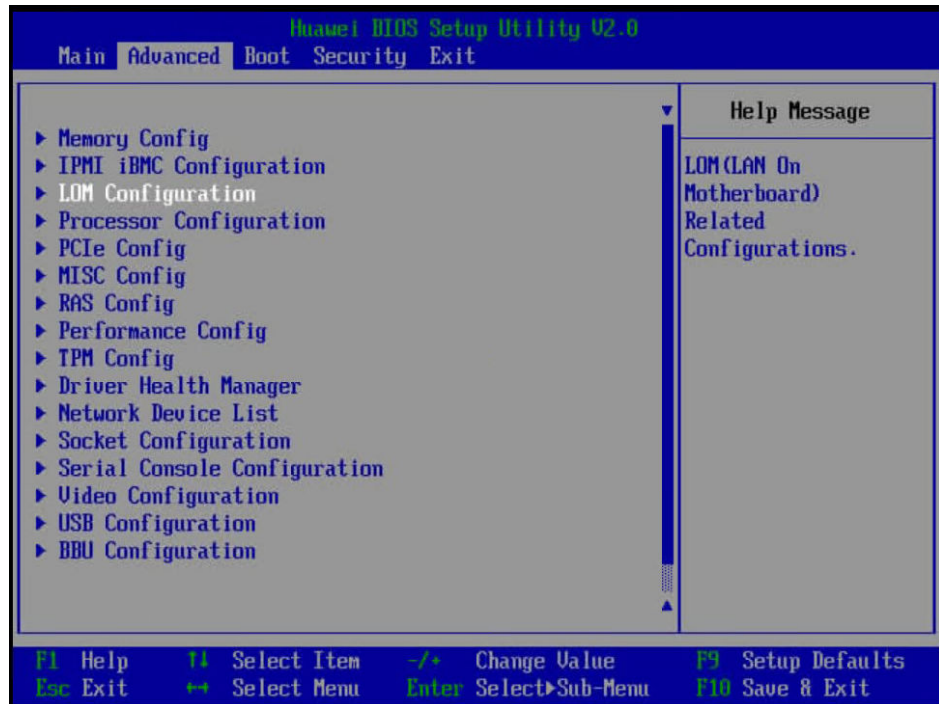
**Step 5** Select **Yes** and press **Enter**.

----End

## Set the PXE

- Setting the PXE for an LAN on motherboard (LOM)
  - a. Select **Advanced** and press **Enter**.  
The **Advanced** screen is displayed, as shown in [Figure 5-41](#).

Figure 5-41 Advanced screen



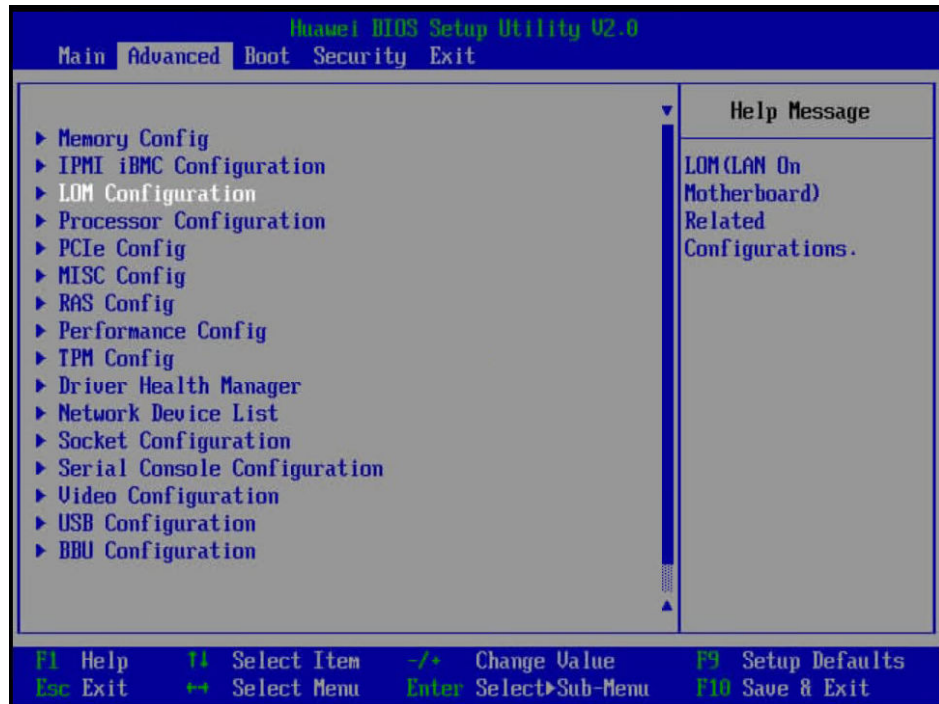
- b. Select **LOM Configuration > PXE Configuration** and press **Enter**.
  - c. Set the PXE for NICs.
    - i. Select the network port such as **PXE1 Configuration**, and press **Enter**.
    - ii. In the dialog box that is displayed, select **Enable** and press **Enter**.
  - d. Select **PXE Boot Capability** and press **Enter**. In the dialog box that is displayed, select the PXE boot network protocol.
    - UEFI: IPv4
    - UEFI: IPv6
    - UEFI: IPv4/IPv6
  - e. Press **F10**.  
The system displays "Save configuration changes and reset and exit?"
  - f. Select **Yes** and press **Enter** to save the setting.
- Setting the PXE for a NIC connected to the server

**NOTE**

The displayed information varies according to the external NIC when you configure the PXE. The following procedure uses the SP570 NIC as an example.

- a. Select **Advanced** and press **Enter**.  
The **Advanced** screen is displayed, as shown in [Figure 5-42](#).

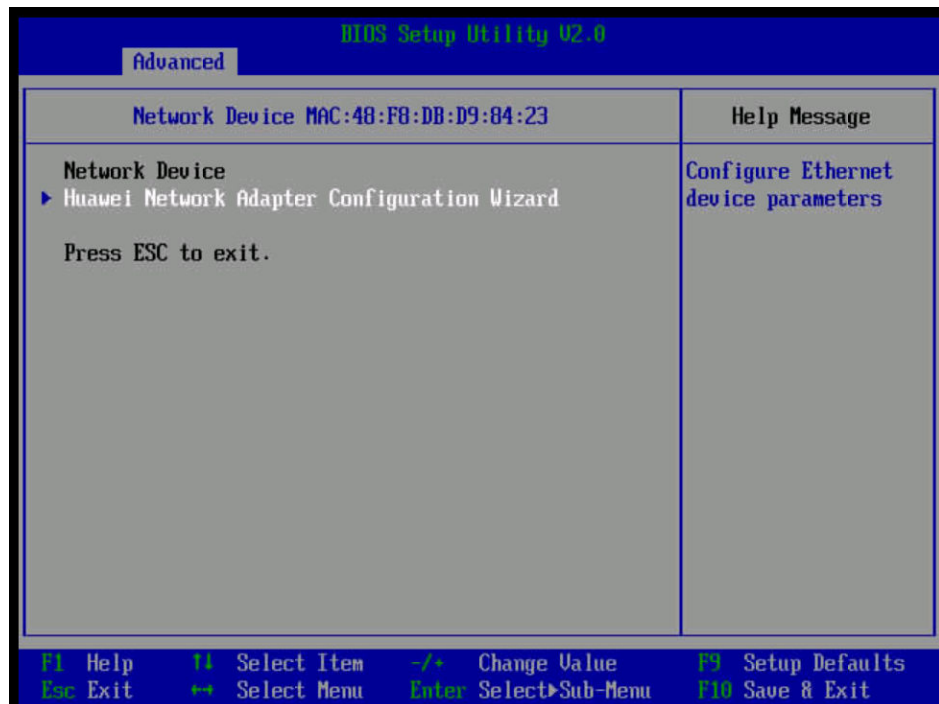
Figure 5-42 Advanced screen



- b. Select **Network Device List** and press **Enter**.
- c. Select the network port (such as **Network Device MAC: 48:F8:DB:D9:84:23**) of the external NIC and press **Enter**.

The **Network Device MAC:48:F8:DB:D9:84:23** screen is displayed, as shown in [Figure 5-43](#).

Figure 5-43 Network Device MAC:48:F8:DB:D9:84:23 screen

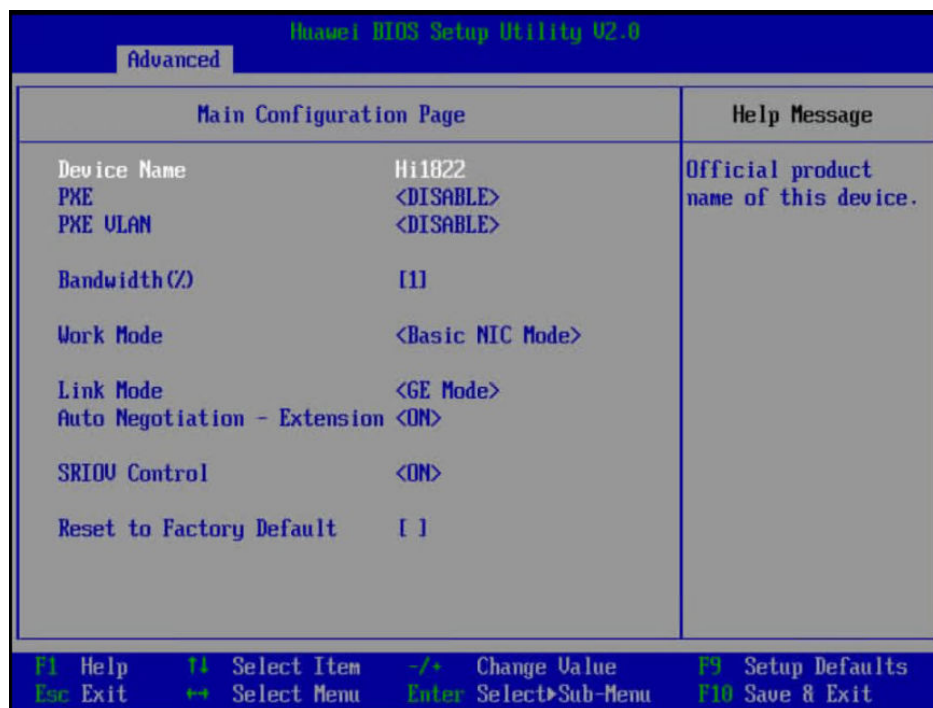




- d. Select **Huawei Network Adapter Configuration Wizard** and press **Enter**.

The **Main Configuration Page** screen is displayed, as shown in [Figure 5-44](#).

**Figure 5-44** Main Configuration Page screen

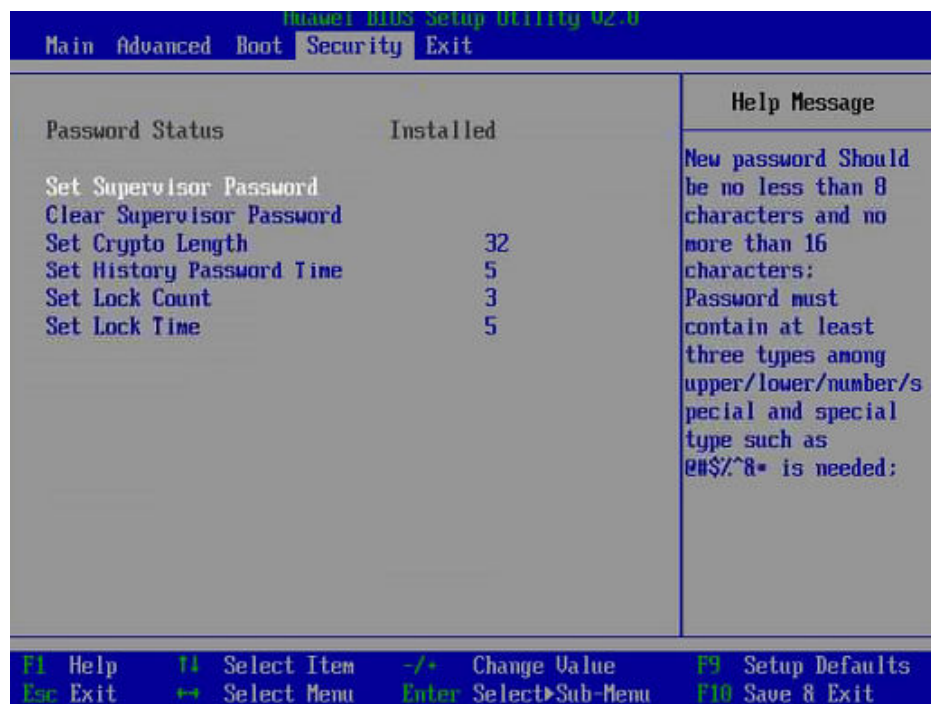


- e. Set the parameters as required.
- f. Press **F10**.  
The system displays "Save configuration changes and reset and exit?"
- g. Select **Yes** and press **Enter** to save the setting.

## Set the BIOS password

**Step 1** Press ← or → to select the **Security** menu, as shown in [Figure 5-45](#).

Figure 5-45 Security



**Step 2** Select **SET Supervisor Password** and press **Enter**, and set the administrator password. Before setting the password, you must enter the current administrator password.

**NOTE**

- The administrator password must meet the following requirements:
  - Contains 8 to 16 characters.
  - Contains special characters (including spaces) and at least two types of the following characters: uppercase letters, lowercase letters, and digits.
  - Cannot be the same as any of the previous five passwords.
- The default password is **Admin@9000**.

**Step 3** (Optional) After a password is set, select **Clear Supervisor Password** to delete the password.

**Step 4** Press **F10**.

The **Save Configuration&Exit** dialog box is displayed.

**Step 5** Select **Yes** and press **Enter**.

----End

## Selecting a Language

**Step 1** On the **Main** screen, choose **Select Language**, as shown in [Figure 5-46](#).

Figure 5-46 Main screen



**Step 2** Press **Enter**.

The **Language** screen is displayed.

**Step 3** Select the language to be used and press **Enter**.

**Step 4** Press **F10**.

The system displays "Save configuration changes and reset and exit?"

**Step 5** Select **Yes** and press **Enter** to save the settings.

----End

## 5.10.9 Installing an OS

The server is compatible with different types of OSs. Use the **Intelligent Computing Compatibility Checker** to check compatible OSs.

The installation method varies according to the OS type. For details, see the installation guide of each OS.

### NOTE

You can log in to <https://support.huawei.com/enterprise>, choose **TECHNICAL SUPPORT > Product Support > Server - Intelligent Computing > TaiShan Servers**, and click the product model to go to the document page of the product. Then search, browse, and download the installation guide of each OS.

## 5.10.10 Upgrading the System

### NOTE

Upgrade server drivers, firmware, and management software as needed.

### Obtaining Documents

[\*TaiShan Rack Server Upgrade Guide\*](#)

[\*TaiShanServer iDriver 3.0.0 Driver Version Mapping\*](#)

[\*Release Notes\*](#)

### Upgrading Firmware or Management Software

Upgrade the raid card firmware, mainboard CPLD and drive backplane CPLD on the iBMC WebUI. For details, see the [\*TaiShan Rack Server Upgrade Guide\*](#).

### Updating Drivers

If the existing driver versions on a server are inconsistent with those in the driver version mapping, install the drivers of required versions. Otherwise, the server may operate abnormally. For details, see the OS installation guide.

# 6 Troubleshooting

---

The *TaiShan Server Troubleshooting* covers:

- Troubleshooting process  
Troubleshooting is a process of using appropriate methods to find the cause of a fault and rectify the fault. The troubleshooting process is to narrow down the scope of possible causes for a fault to reduce troubleshooting complexity, identify the root cause, and rectify the fault.
- Fault information collection  
If a fault occurs on a server, collect logs for fault diagnosis.
- Fault diagnosis  
Fault diagnosis rules and tools help Huawei technical support engineers and maintenance engineers to analyze and rectify faults according to alarms and hardware fault symptoms.
- Software and firmware upgrade  
Software and firmware upgrade packages can be downloaded by server model and installed as needed.
- Preventive maintenance  
Preventive maintenance promptly detects, diagnoses, and rectifies server faults.

# 7 Warranty and Safety

---

## 7.1 Maintenance and Warranty

For details, see [Maintenance & Warranty](#).

## 7.2 Safety

For details, see [Huawei Server Safety Information](#).

# 8 Common Operations

---

## 8.1 Logging In to the Remote Virtual Console

### 8.1.1 Logging In to the Remote Virtual Console through the iBMC WebUI

#### Procedure (Earlier Than iBMC V500)

**Step 1** Log in to the iBMC WebUI.

For details, see [5.10.4 Logging In to the iBMC WebUI](#).

**Step 2** On the menu bar, choose **Remote Console**. The **Remote Console** page is displayed, as shown in [Figure 8-1](#).

**Figure 8-1** Remote Console page

Remote Console
🔄 🌐

---

**Integrated Remote Console**

The Java integrated remote console requires Java Runtime Environment (JRE) to be installed. Click [here](#) to download JRE. [More information...](#)

[Java Integrated Remote Console \(Private\)](#)

[Java Integrated Remote Console \(Shared\)](#)

[HTML5 Integrated Remote Console \(Private\)](#)

[HTML5 Integrated Remote Console \(Shared\)](#)

---

**Independent Remote Console**

With the Independent Remote Console (IRC), you can access and manage the server in real time. The IRC does not depend on the browser, OS, or JRE version. [Download](#).

---

**Remote Console Settings**

Timeout Period (min)	<input type="text" value="0"/>
Maximum Sessions	2
Active Sessions	0
Encryption	<input type="checkbox"/>
Enable Local KVM	<input type="checkbox"/>
Persistent Virtual Keyboard and Mouse	<input checked="" type="checkbox"/>

[Save](#)

---

**Virtual Media**

Maximum Sessions	1
Active Sessions	0
Encryption	<input type="checkbox"/>

[Save](#)

---

**VNC Service**

Timeout Period (min)	<input type="text"/>
Keyboard Layout	<input type="text"/> ▾
VNC Password	<input type="text"/>
Confirm Password	<input type="text"/>
Password Validity (Days)	Unlimited
Login Rules	<input type="checkbox"/> Rule1 <input type="checkbox"/> Rule2 <input type="checkbox"/> Rule3 <a href="#">View login rules</a>
SSL Encryption	<input checked="" type="checkbox"/>
Maximum Sessions	5
Active Sessions	0

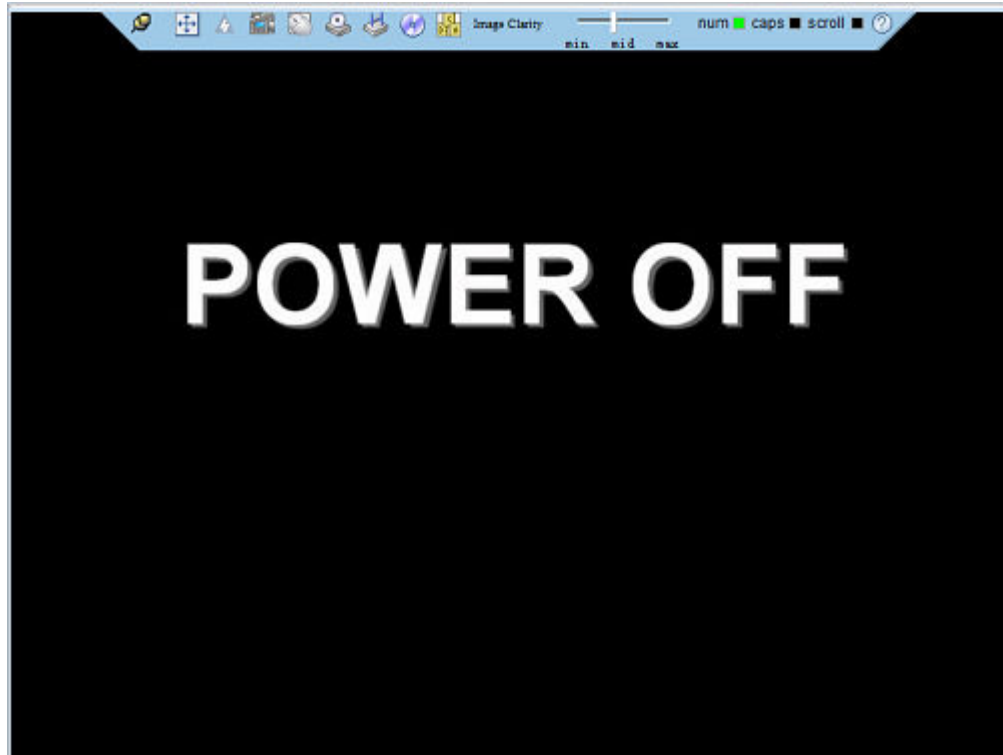
**Step 3** Click **Java Integrated Remote Console (Private)**, **Java Integrated Remote Console (Shared)**, **HTML5 Integrated Remote Console (Private)**, or **HTML5 Integrated Remote Console (Shared)** to access the real-time operation console of the server, as shown in [Figure 8-2](#) and [Figure 8-3](#).

**NOTE**

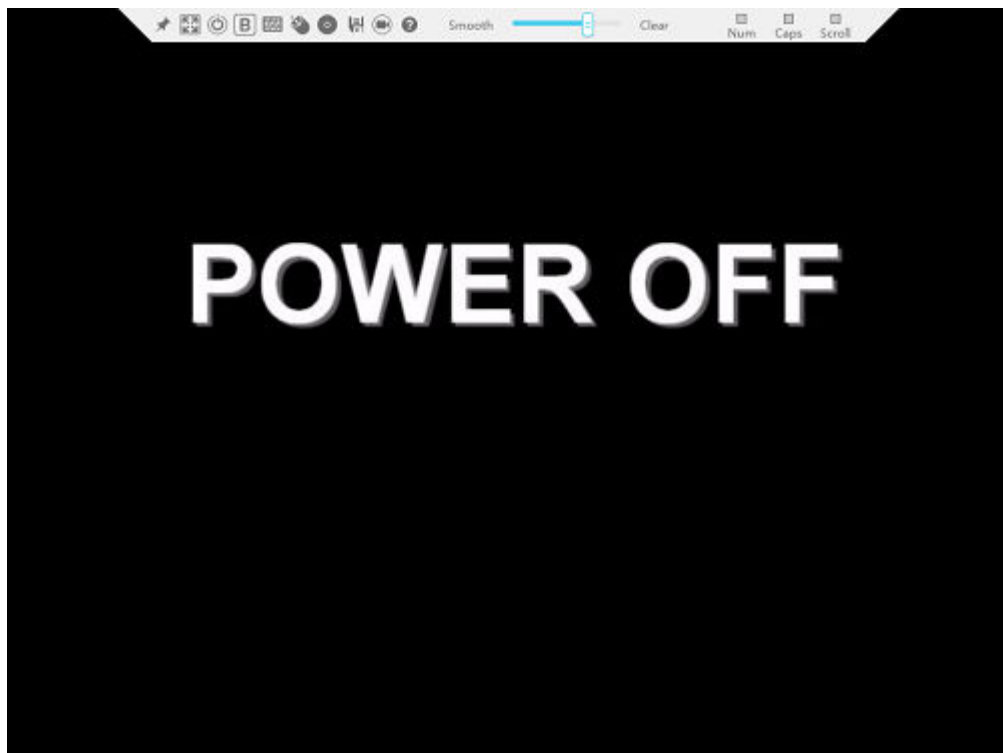
- **Java Integrated Remote Console (Private):** allows only one local user or VNC user to access and manage the server at a time.
- **Java Integrated Remote Console (Shared):** allows two local users or five VNC users to access and manage the server at a time. The users can see each other's operations.
- **HTML5 Integrated Remote Console (Private):** allows only one local user or VNC user to access and manage the server at a time.
- **HTML5 Integrated Remote Console (Shared):** allows two local users or five VNC users to access and manage the server at a time. The users can see each other's operations.



**Figure 8-2** Real-time operation console (Java)



**Figure 8-3** Real-time operation console (HTML5)



----End

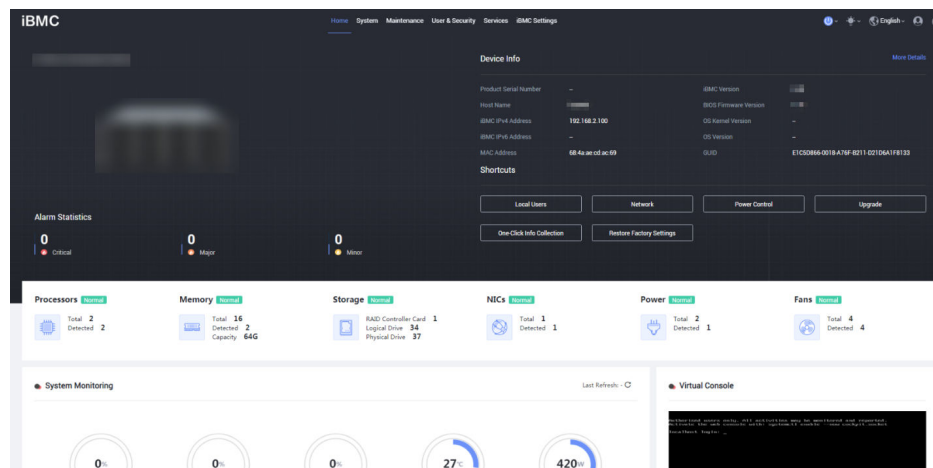
## Procedure (iBMC V500 and Later)


**Step 1** Log in to the iBMC WebUI.

For details, see [5.10.4 Logging In to the iBMC WebUI](#).

**Step 2** In the lower right corner of the home page, click **Virtual Console**. See [Figure 8-4](#).

**Figure 8-4** Virtual console

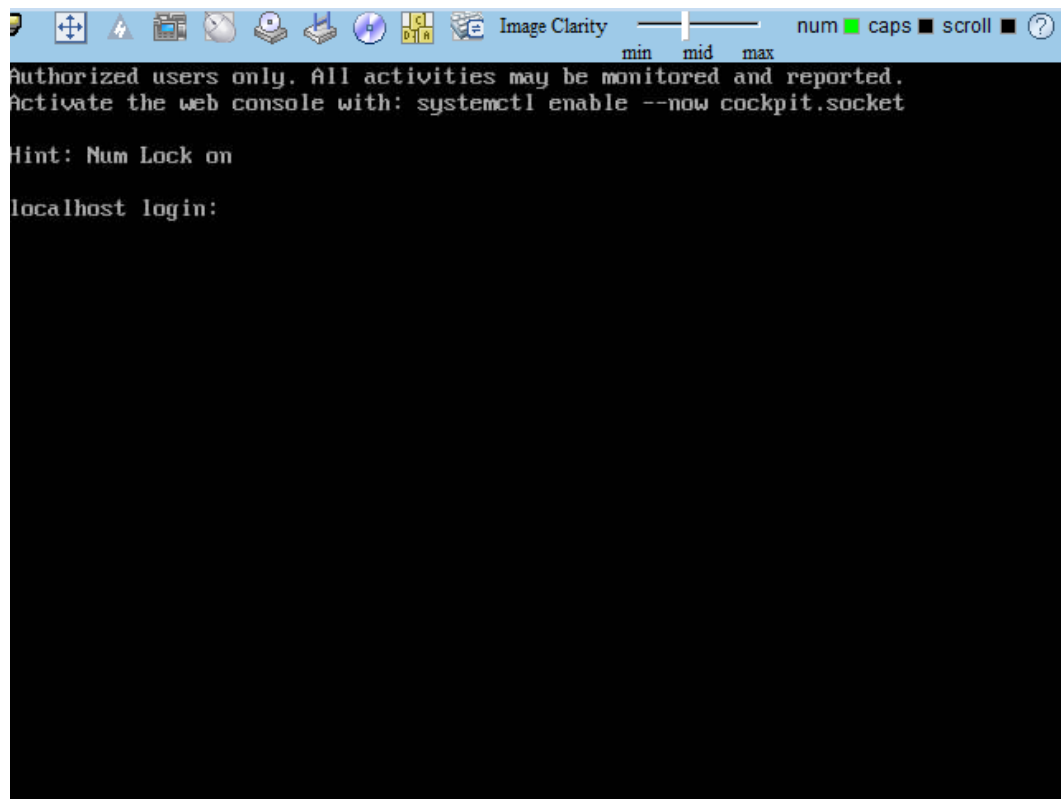


**Step 3** Click  on the right of **Start** and select **Java Integrated Remote Console (Private)**, **Java Integrated Remote Console (Shared)**, **HTML5 Integrated Remote Console (Private)**, or **HTML5 Integrated Remote Console (Shared)** to log in to the remote virtual console. See [Figure 8-5](#) or [Figure 8-6](#).

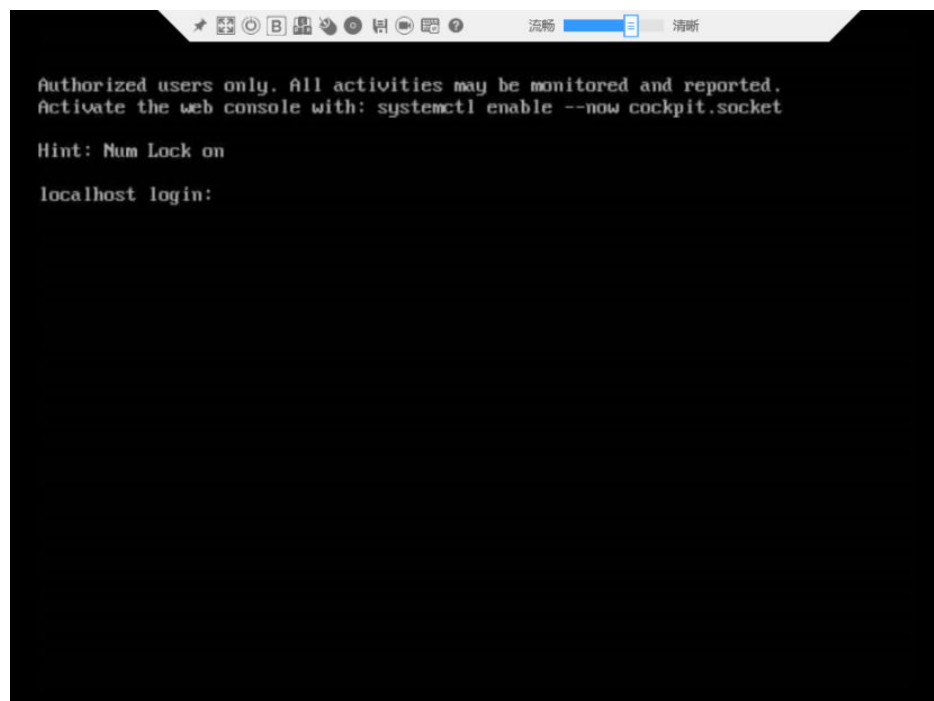
### NOTE

- **Java Integrated Remote Console (Private):** allows only one local user or VNC user to access and manage the server at a time.
- **Java Integrated Remote Console (Shared):** allows two local users or five VNC users to access and manage the server at a time. The users can see each other's operations.
- **HTML5 Integrated Remote Console (Private):** allows only one local user or VNC user to access and manage the server at a time.
- **HTML5 Integrated Remote Console (Shared):** allows two local users or five VNC users to access and manage the server at a time. The users can see each other's operations.

**Figure 8-5** Real-time operation console (Java)



**Figure 8-6** Real-time operation console (HTML5)



----End

## 8.1.2 Logging In to the Server Using the IRC

Download the Independent Remote Console (IRC) at [IRC](#).

### Windows

The following Windows versions are supported:

- Windows 7 32-bit or 64-bit
- Windows 8 32-bit or 64-bit
- Windows 10 32-bit or 64-bit
- Windows Server 2008 R2 32-bit or 64-bit
- Windows Server 2012 64-bit

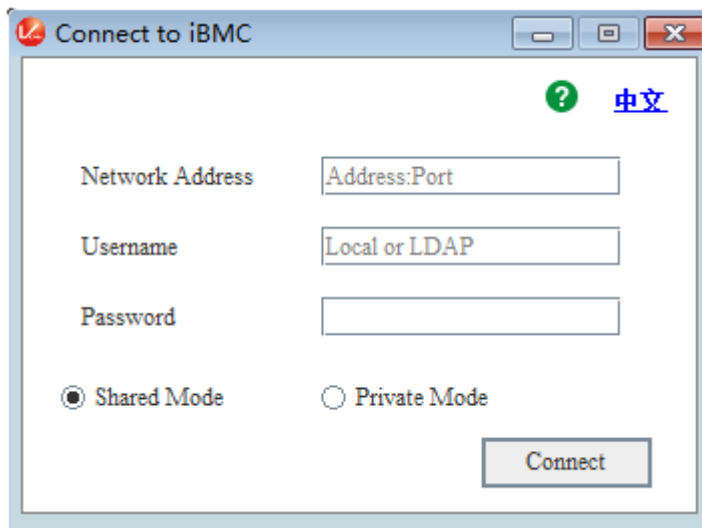
**Step 1** Configure an IP address for the client (PC) to enable communication between the client and the iBMC.

The IP address configured and the iBMC management network port IP address must be on the same network segment.

**Step 2** Double-click **KVM.exe**.

A dialog box similar to the one shown in [Figure 8-7](#) is displayed.

**Figure 8-7** Login interface



**Step 3** Enter the network address, user name, and password.

The network address can be in any of the following formats:

- *iBMC management network port IP address (IPv4 or IPv6 address):Port number*
- *iBMC domain name address:Port number*

 **NOTE**

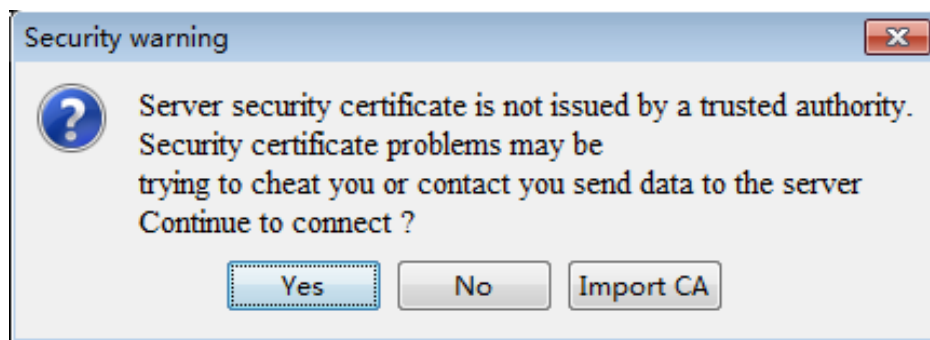
- Enter an IPv6 address in brackets or an IPv4 address directly, for example, **[2001::64]:444** or **192.168.100.1:444**.
- When the port number is the default port number **443**, the port number can be left blank.

**Step 4** Select a login mode, and click **Connect**.

- **Shared Mode:** allows two users to access and manage a server at a time. The two users can see each other's operations.
- **Private Mode:** allows only one user to access and manage a server at a time.

Information shown in **Figure 8-8** is displayed.

**Figure 8-8** Security risk information

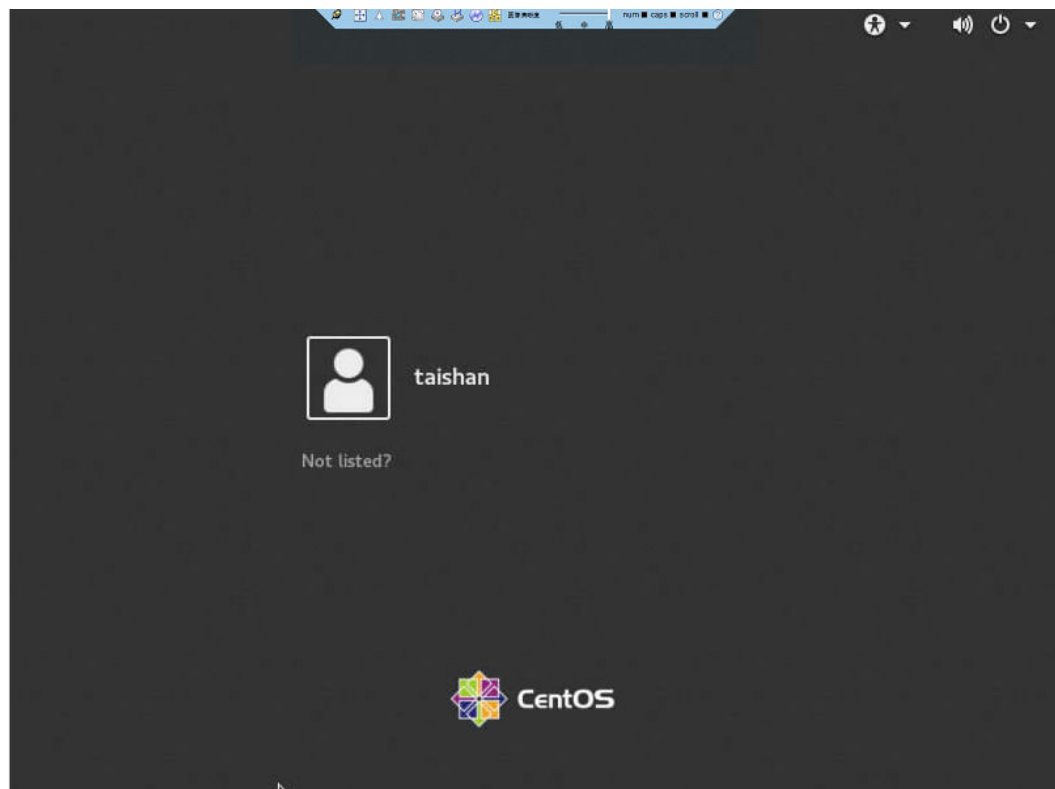


**Step 5** Perform any of the following operations based on the actual situation:

- Click **Yes** to open the IRC.
- Click **No** to return to the login interface.
- Click **Import CA** to import the CA certificate (\*.cer, \*.crt, or \*.pem). After the CA certificate is imported, the security risk dialog box will no longer be displayed.

The IRC of the server is displayed, as shown in **Figure 8-9**.

**Figure 8-9** IRC of the server



----End

## Ubuntu

Supported OSs: Ubuntu 14.04 LTS and Ubuntu 16.04 LTS

**Step 1** Configure an IP address for the client (PC) to enable communication between the client and the iBMC.

The IP address configured and the iBMC management network port IP address must be on the same network segment.

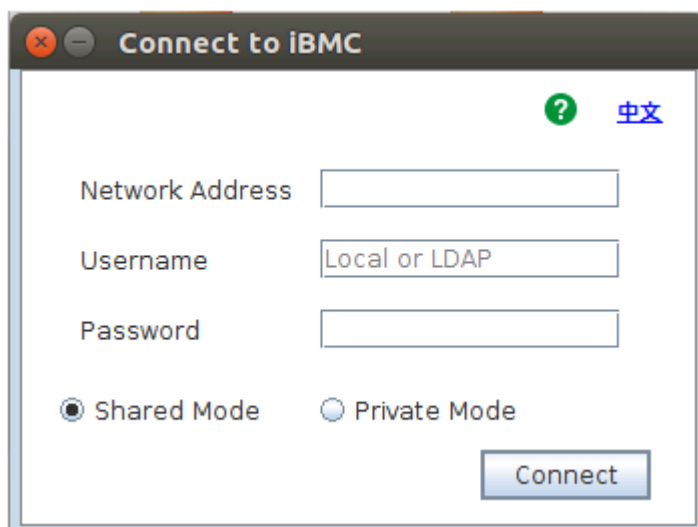
**Step 2** Open the console and set the folder where the IRC is stored as the working folder.

**Step 3** Run the **chmod 777 KVM.sh** command to set the permission for the IRC.

**Step 4** Run **./KVM.sh** to start the IRC.

A dialog box similar to the one shown in [Figure 8-10](#) is displayed.

**Figure 8-10** Login interface



**Step 5** Enter the network address, user name, and password.

The network address can be in any of the following formats:

- *iBMC management network port IP address (IPv4 or IPv6 address):Port number*
- *iBMC domain name address:Port number*

**NOTE**

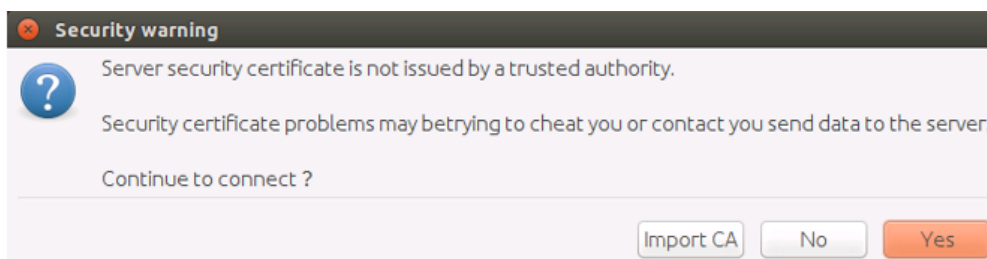
- Enter an IPv6 address in brackets or an IPv4 address directly, for example, **[2001::64]:444** or **192.168.100.1:444**.
- When the port number is the default port number **443**, the port number can be left blank.

**Step 6** Select a login mode, and click **Connect**.

- **Shared Mode:** allows two users to access and manage a server at the same time. The two users can see each other's operations.
- **Private Mode:** allows only one user to access and manage a server at a time.

Information shown in **Figure 8-11** is displayed.

**Figure 8-11** Security risk information



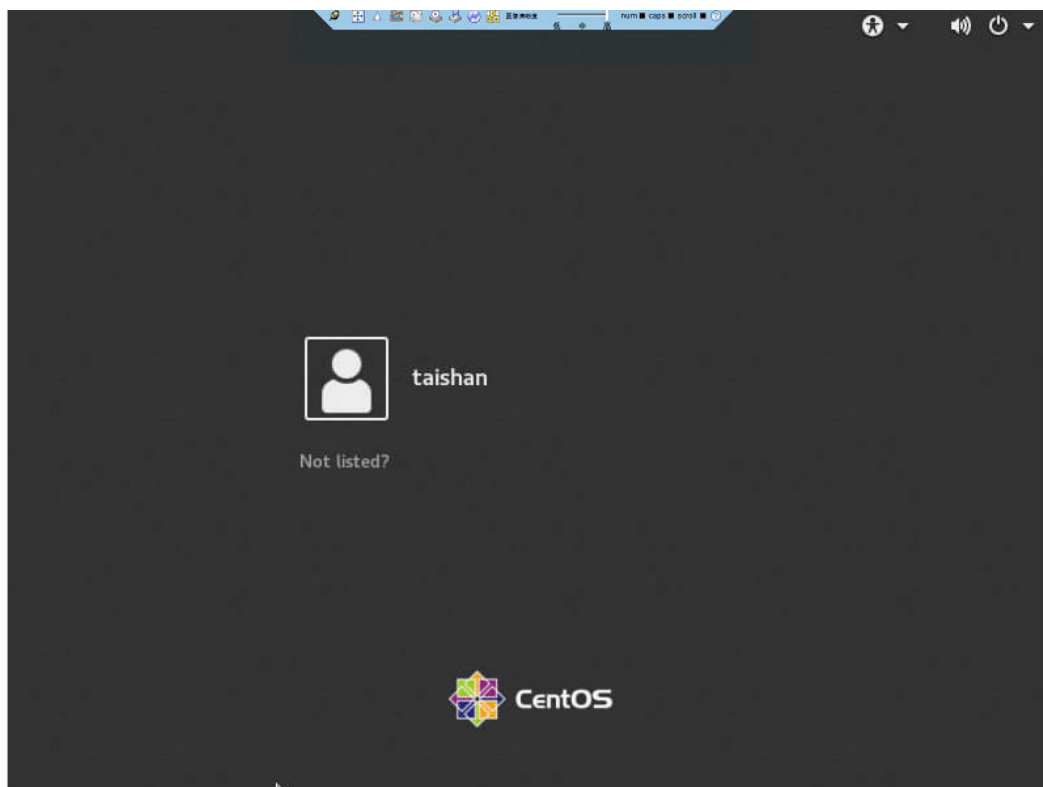
**Step 7** Perform any of the following operations based on the actual situation:

- Click **Yes** to open the IRC.
- Click **No** to return to the login interface.

- Click **Import CA** to import the CA certificate (\*.cer, \*.crt, or \*.pem). After the CA certificate is imported, the security risk dialog box will no longer be displayed.

The IRC of the server is displayed, as shown in [Figure 8-12](#).

**Figure 8-12** IRC of the server



----End

## Mac OS

Supported OS: Mac OS X El Capitan

- Step 1** Configure an IP address for the client (PC) to enable communication between the client and the iBMC.

The IP address configured and the iBMC management network port IP address must be on the same network segment.

- Step 2** Open the console and set the folder where the IRC is stored as the working folder.

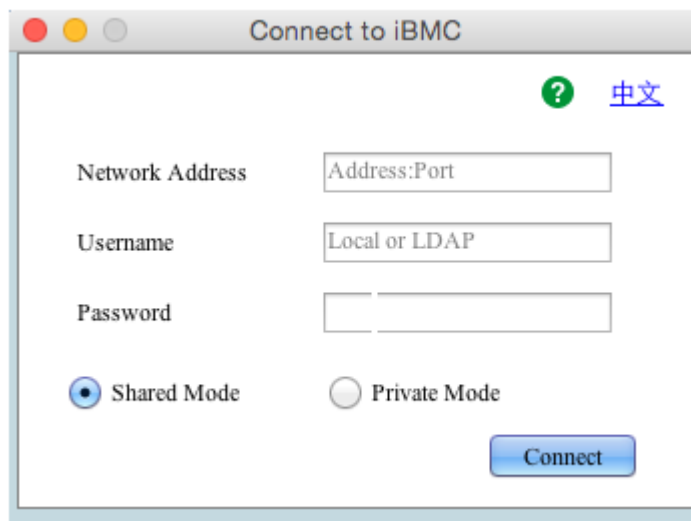
- Step 3** Run the **chmod 777 KVM.sh** command to set the permission for the IRC.

- Step 4** Run **./KVM.sh** to start the IRC.

A dialog box similar to the one shown in [Figure 8-13](#) is displayed.



**Figure 8-13** Login interface



**Step 5** Enter the network address, user name, and password.

The network address can be in any of the following formats:

- *iBMC management network port IP address (IPv4 or IPv6 address):Port number*
- *iBMC domain name address:Port number*

**NOTE**

- Enter an IPv6 address in brackets or an IPv4 address directly, for example, **[2001::64]:444** or **192.168.100.1:444**.
- When the port number is the default port number **443**, the port number can be left blank.

**Step 6** Select a login mode, and click **Connect**.

- **Shared Mode:** allows two users to access and manage a server at the same time. The two users can see each other's operations.
- **Private Mode:** allows only one user to access and manage a server at a time.

Information shown in [Figure 8-14](#) is displayed.

**Figure 8-14** Security risk information

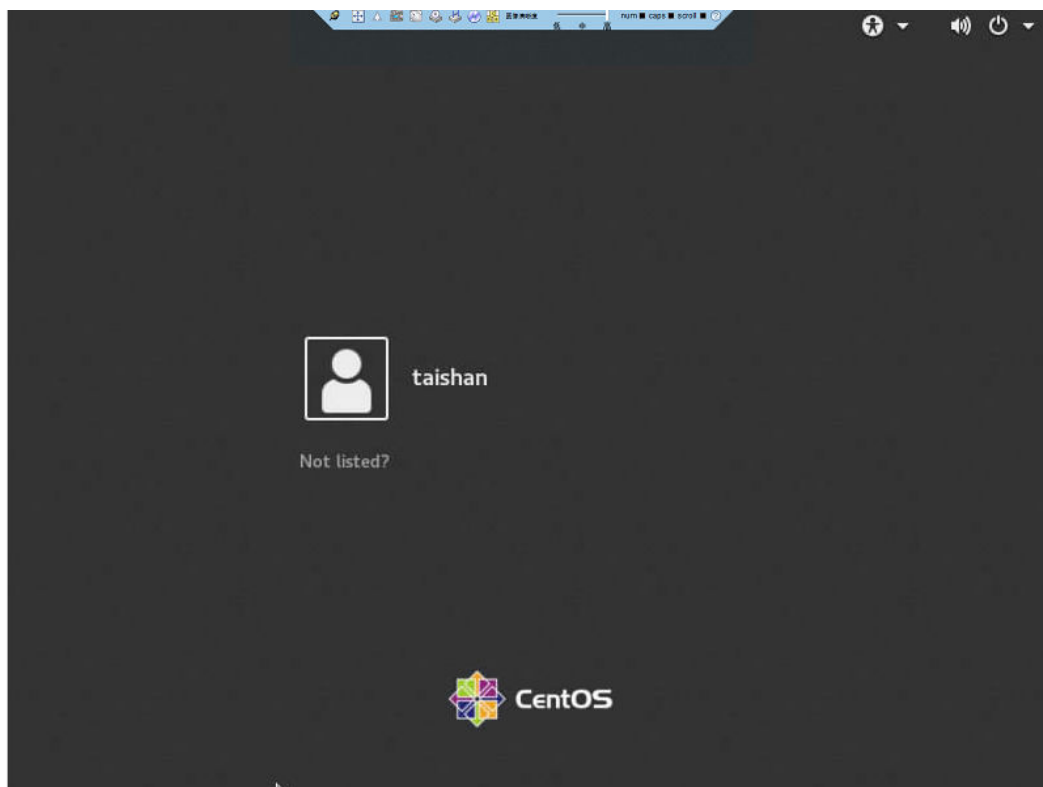


**Step 7** Perform any of the following operations based on the actual situation:

- Click **Yes** to open the IRC.
- Click **No** to return to the login interface.
- Click **Import CA** to import the CA certificate (\*.cer, \*.crt, or \*.pem). After the CA certificate is imported, the security risk dialog box will no longer be displayed.

The IRC of the server is displayed, as shown in **Figure 8-15**.

**Figure 8-15** IRC of the server



----End

## 8.2 Logging In to the iBMC CLI

### NOTE

- A user will be locked out after five consecutive login failures with wrong passwords. The user is automatically unlocked 5 minutes later, and an administrator can unlock the user on the CLI.
- For security purposes, change your initial password at your first login and change the password periodically.
- By default, the CLI timeout interval is 15 minutes.

### Logging In over SSH

Secure Shell (SSH) provides secure remote login and other network services on a non-secure network. A maximum of five users can log in over SSH at the same time.

 **NOTE**

SSH supports the **AES128-CTR**, **AES192-CTR**, and **AES256-CTR** encryption algorithms. When you log in to the iBMC over SSH, select a proper encryption algorithm.

- Step 1** Download an SSH communication tool to a local client.
- Step 2** Connect the client to the server management network port directly or through a network.
- Step 3** Set the client IP address so that the client can communicate with the server iBMC management network port.
- Step 4** On the client, open the SSH tool and set related parameters, such as the IP address.
- Step 5** Connect to the iBMC and enter the user name and password.

 **NOTE**

- Local and LDAP users can both log in to the iBMC CLI over SSH.
- To log in to the iBMC, LDAP users do not need to enter information about the domain server, which is automatically assigned by the system.

----End

## Logging In over the Serial Port

- Step 1** Set the serial port as the iBMC serial port.
  - To set the serial port through the iBMC CLI, do as follows:
    - a. Log in to the iBMC CLI over SSH.
    - b. Run the following command to change the serial port direction:  
**ipmcset -d serialdir -v <option>**

Parameter	Description	Value
<option>	Serial port direction	<p>The value options of this parameter and the value meanings vary according to the server model. You are advised to run the <b>ipmcget -d serialdir</b> command to view the value options.</p> <p>For the server, the options are as follows:</p> <ul style="list-style-type: none"> <li>- <b>0</b>: sets the serial port on the server panel as the system serial port.</li> <li>- <b>1</b>: sets the serial port on the server panel as the iBMC serial port.</li> <li>- <b>2</b>: sets the SOL port as the system serial port.</li> <li>- <b>3</b>: sets the SOL port as the iBMC serial port.</li> <li>- <b>4</b>: sets the serial port on the SDI V3 card panel as an SCCL port.</li> <li>- <b>5</b>: sets the serial port on the SDI V3 card panel as an IMU port.</li> <li>- <b>6</b>: sets the serial port on the SDI V3 card panel as an SCCL port.</li> <li>- <b>7</b>: sets the serial port on the SDI V3 card panel as an IMU port.</li> </ul> <p>To set the panel serial port as the iBMC serial port, run the <b>ipmcset -d serialdir -v 1</b> command.</p> <p><b>NOTE</b></p> <ul style="list-style-type: none"> <li>- If no SDI V3 is installed in a server, &lt;option&gt; can be 0 to 3 only.</li> <li>- If one SDI V3 card is installed, the values 4 and 5 are available for setting the ports on the SDI V3 in I/O module 1 or 2.</li> <li>- If two SDI V3 cards are installed, the values 4 to 7 are available. The values 4 and 5 are used for setting the ports on the SDI V3 in I/O module 1, while the values 6 and 7 are for the ports on the SDI V3 in I/O module 2.</li> </ul>

- To set the serial port by using a jumper, do as follows:
  - a. Power off the server and remove the power cables.
  - b. Place the jumper cap on COM\_SW pins. For details about the jumper position, see **Mainboard and iBMC Card Connectors** in the [TaiShan 200 Server Maintenance and Service Guide \(Model 2280\)](#).
  - c. Connect the power cables and power on the server.

**Step 2** Use a serial cable to connect the terminal serial port and the server serial port.

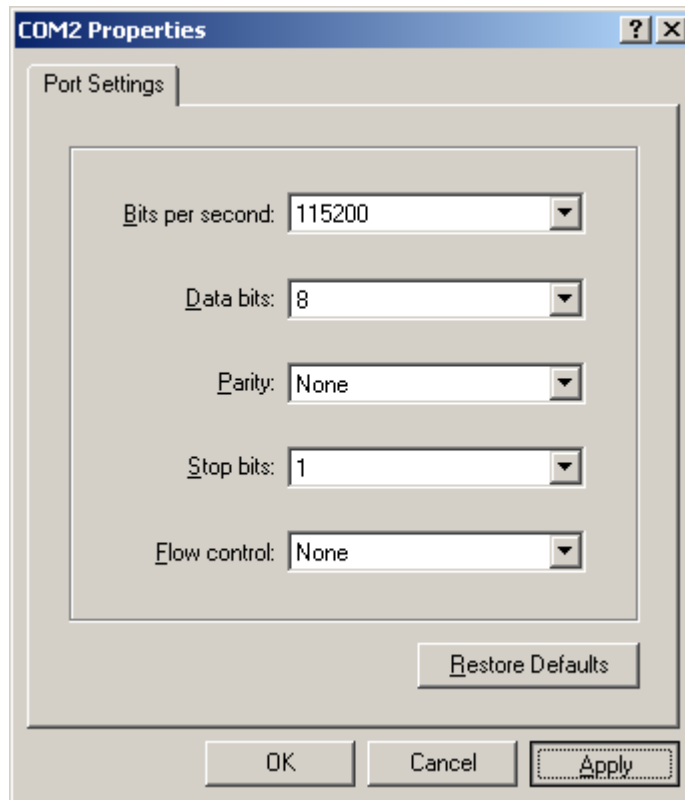
**Step 3** Open HyperTerminal and set the following parameters:

- **Bits per second:** 115200
- **Data bits:** 8

- **Parity:** None
- **Stop bits:** 1
- **Flow control:** None

Figure 8-16 shows the port settings.

Figure 8-16 HyperTerminal Properties



**Step 4** Enter the user name and password to access the CLI.

----End

## 8.3 Logging In to the Server over a Serial Port Using PuTTY

Use PuTTY to log in to the server over a serial port in any of the following scenarios:

- The server is configured for the first time at a site.
- A remote connection to the server cannot be established.

### NOTE

- Visit the [chark website](#) and download the PuTTY software from the homepage.
- PuTTY of an earlier version may cause server login failures. You are advised to use PuTTY of the latest version.

## Procedure

**Step 1** Double-click **PuTTY.exe**.

The **PuTTY Configuration** window is displayed.

**Step 2** In the navigation tree, choose **Connection > Serial**.

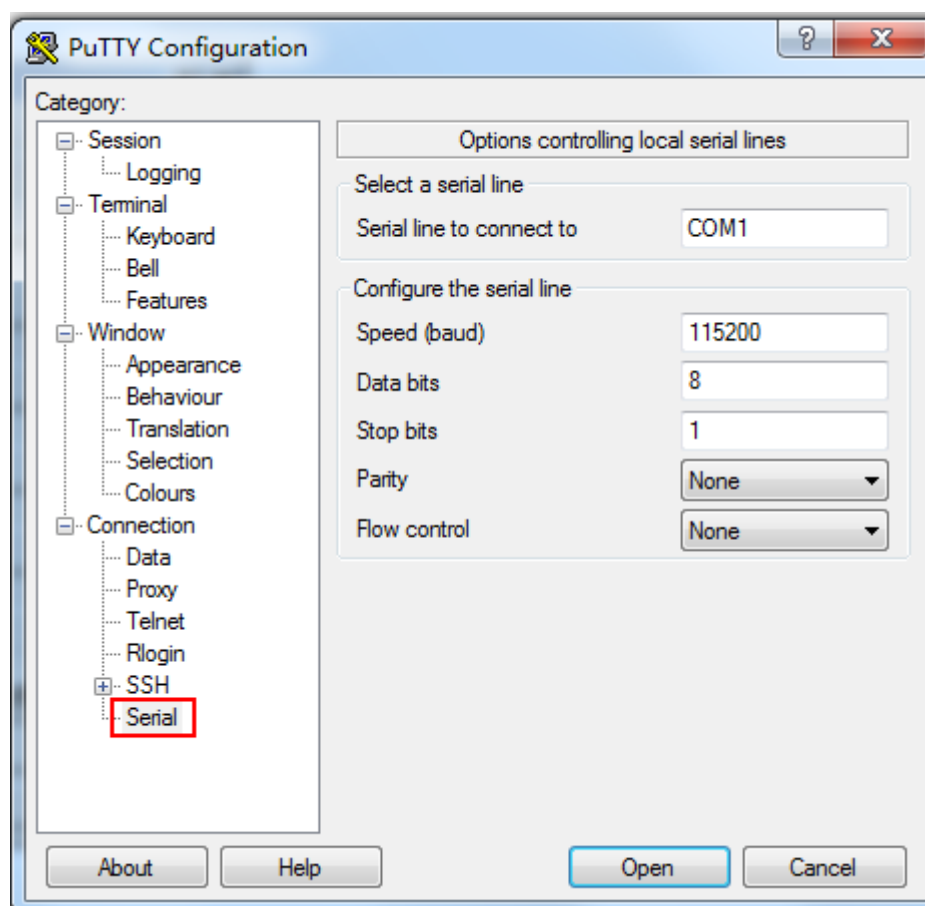
**Step 3** Set the login parameters.

Example:

- **Serial Line to connect to:** COM $n$
- **Speed (baud):** 115200
- **Data bits:** 8
- **Stop bits:** 1
- **Parity:** None
- **Flow control:** None

$n$  in COM $n$  indicates a serial port number, and its value is an integer.

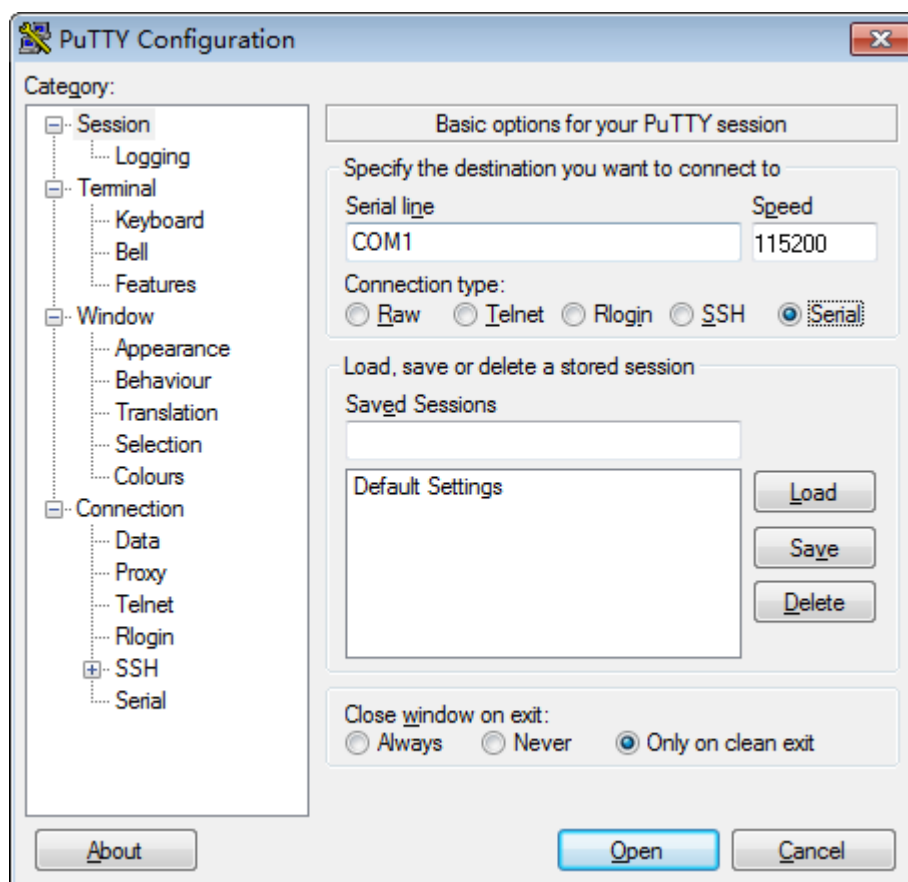
**Figure 8-17** PuTTY Configuration - Serial



**Step 4** In the navigation tree, choose **Session**.

**Step 5** Select **Serial** under **Connection type**, as shown in [Figure 8-18](#).

**Figure 8-18** PuTTY Configuration - Session



**Step 6** Set **Close window on exit** to **Only on clean exit**, as shown in [Figure 8-18](#).

Set **Saved Sessions** and click **Save**. Next time you can simply double-click the saved settings under **Saved Sessions** to log in to the server.

**Step 7** Click **Open**.

The **PuTTY** window is displayed.

**Step 8** Enter the user name and password.

If the login is successful, the server host name is displayed on the left of the prompt.

----End

## 8.4 Logging In to the Server over a Network Port Using PuTTY

The login method described in this chapter applies to components that support SSH access, for example, iBMC and OS.

Use PuTTY to remotely log in to the server over a local area network (LAN) and configure and maintain the server.

**NOTE**

- Visit the [chiark website](#) and download the PuTTY software from the homepage.
- PuTTY of an earlier version may cause server login failures. You are advised to use PuTTY of the latest version.

## Procedure

**Step 1** Set an IP address and a subnet mask or add route information for the PC to communicate with the server.

On the PC command-line interface (CLI), run the following command to check whether the IP address is reachable:

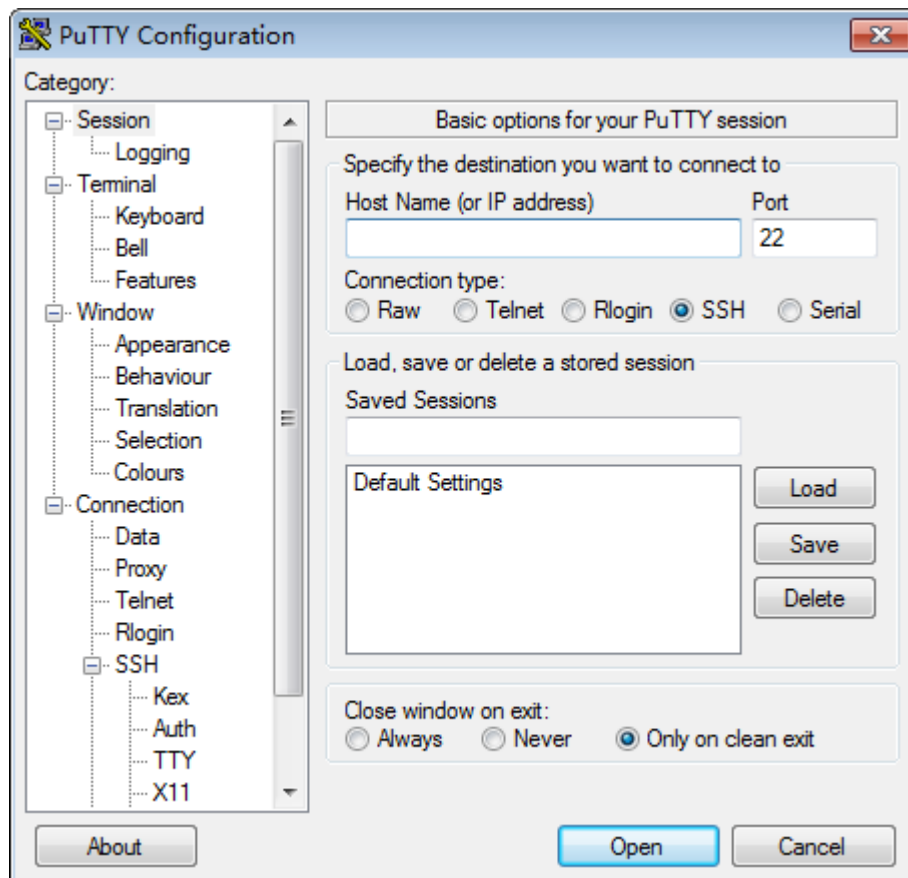
### Ping *Server IP address*

- If yes, go to [Step 2](#).
- If no, check the network connection, rectify the fault, and go to [Step 1](#).

**Step 2** Double-click **PuTTY.exe**.

The **PuTTY Configuration** window is displayed, as shown in [Figure 8-19](#).

**Figure 8-19** PuTTY Configuration window



**Step 3** In the navigation tree, choose **Session**.

**Step 4** Set the login parameters.



The parameters are described as follows:

- **Host Name (or IP address):** Enter the IP address of the server to be accessed, for example, **191.100.34.32**.
- **Port:** Retain the default value **22**.
- **Connection type:** Retain the default value **SSH**.
- **Close window on exit:** Retain the default value **Only on clean exit**.

 **NOTE**

Configure **Host Name (or IP address)** and **Saved Sessions**, and click **Save**. You can double-click the saved record under **Saved Sessions** to log in to the server the next time.

**Step 5** Click **Open**.

The **PuTTY** window is displayed.

 **NOTE**

If this is your first login to the server, the **PuTTY Security Alert** dialog box is displayed. Click **Yes** to proceed.

If an incorrect user name or password is entered, you must set up a new PuTTY session.

**Step 6** Enter the user name and password.

If the login is successful, the server host name is displayed on the left of the prompt.

----End

## 8.5 Querying the Processor Model of a Server

You can query the processor model of a server using the following methods:

- Open the chassis cover and remove the CPU heat sink. Check and record the processor model on the mainboard processor silkscreen. For details about how to open the chassis cover and remove the CPU heat sink, see the [TaiShan 200 Server Maintenance and Service Guide \(Model 2280\)](#).
- Query the processor model on the BIOS
- Query the processor model on the iBMC

### Querying the Processor Model on the BIOS

**Step 1** Log in to the Remote Virtual Console. For details, see [8.1 Logging In to the Remote Virtual Console](#).

**Step 2** On **Remote Virtual Console**, click  or  on the menu bar.

**Step 3** Select **Forced System Reset**.

The system displays "Are you sure you want to perform this operation?"

**Step 4** Click **Yes**.

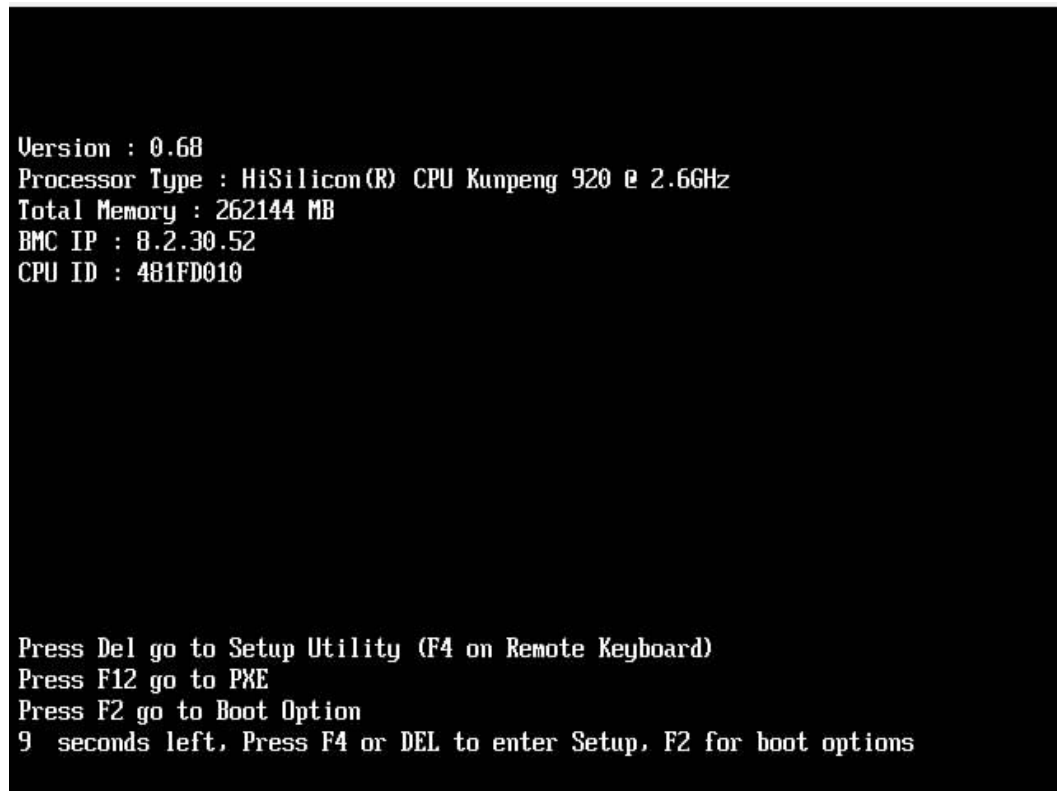
The server is restarted.

**Step 5** Press **Delete** or **F4** if the boot screen shown in [Figure 8-20](#) is displayed.

 **NOTE**

- Press **F12** to boot from the network.
- Press **F2** for boot options.

**Figure 8-20** BIOS boot screen



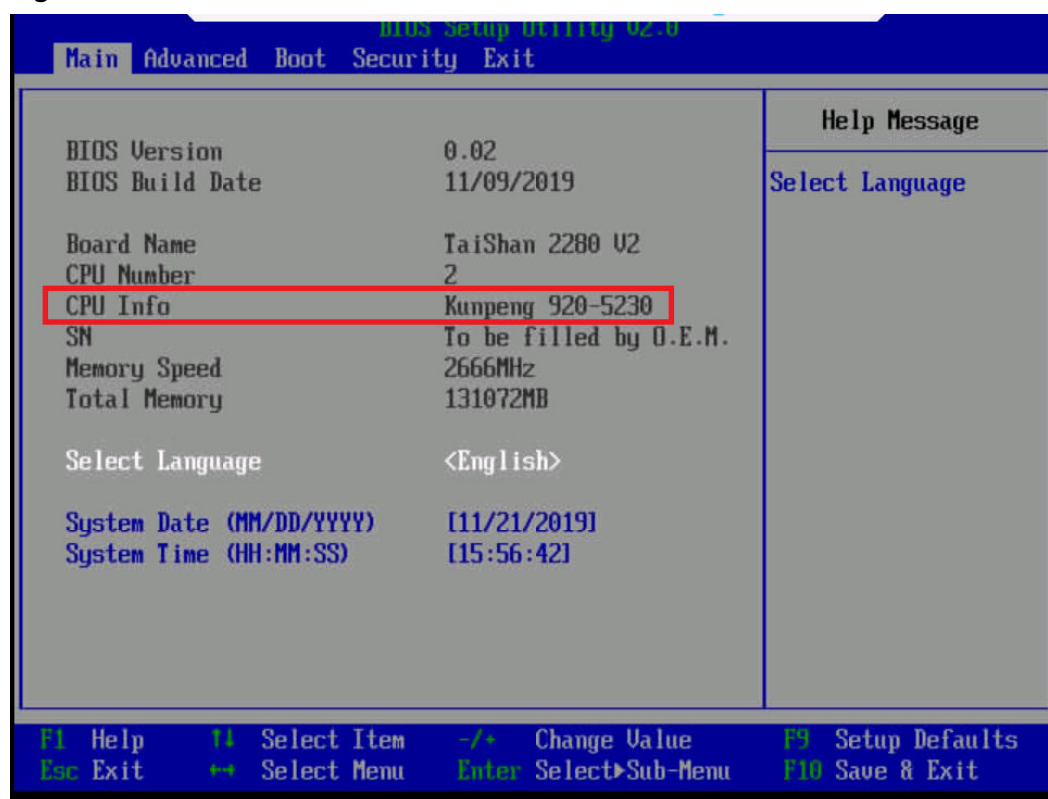
**Step 6** Enter the BIOS password as prompted to switch to the BIOS setting page.

 **NOTE**

- The default BIOS password is **Admin@9000**.
- For security purposes, change the administrator password periodically.
- The system will be locked if an incorrect password is entered three consecutive times. Restart the server to unlock it.

**Step 7** On the **Main** screen, choose **Select Language**, as shown in [Figure 8-21](#).

Figure 8-21 Main screen



**Step 8** Record the value of CPU Info.

----End

## Querying the Processor Model on the iBMC (Earlier Than iBMC V500)

**Step 1** Log in to the iBMC WebUI. For details, see [5.10.4 Logging In to the iBMC WebUI](#).

**Step 2** Choose **Information > System Info > Processors** and view the processor model in the **Model** column.

**Figure 8-22** Querying processor information

Product Info		Processors	Memory	Storage	Fans	Power	Network	Software	Other Devices
Name	CPU1								
Manufacturer	[Redacted]								
Model	[Redacted]								
CPU ID	10-D0-1F-48-00-00-00-00								
Clock Speed	2600 MHz								
Core/Thread Qty	48 cores/48 threads								
L1/L2/L3 Cache	6144/24576/49152 KB								
Status	Enabled								
BOM Code	N/A								
SN	1F83BCD30260E10C								
Other Parameters	64-bit Capable  Multi-Core  Execute Protection  Enhanced Virtualization  Power/Performance Control								
Name	CPU2								
Manufacturer	[Redacted]								
Model	[Redacted]								
CPU ID	10-D0-1F-48-00-00-00-00								
Clock Speed	2600 MHz								
Core/Thread Qty	48 cores/48 threads								
L1/L2/L3 Cache	6144/24576/49152 KB								
Status	Enabled								
BOM Code	N/A								
SN	66D140D30280C10C								
Other Parameters	64-bit Capable  Multi-Core  Execute Protection  Enhanced Virtualization  Power/Performance Control								

----End

## Querying the Processor Model on the iBMC (iBMC V500 or Later)

- Step 1** Log in to the iBMC WebUI. For details, see [5.10.4 Logging In to the iBMC WebUI](#).
- Step 2** Choose **System > System Info** and click **Processors** to view the processor model.

**Figure 8-23** Querying processor information

Product Info	Processors	Memory	NICs	Sensor Info	Others
<b>CPU1</b>					
Name	CPU1				
Manufacturer	[Redacted]				
Model	[Redacted]				
CPU ID	10-D0-1F-48-00-00-00-00				
Clock Speed	2600 MHz				
Cores/Threads	48 cores/48 threads				
L1/L2/L3 Cache	6144/24576/49152 KB				
Status	Enabled				
BOM Code	-				
Serial Number	62F685D301105508				
Other Parameters	64-bit Capable  Multi-Core  Execute Protection  Enhanced Virtualization  Power/Performance Control				
<b>CPU2</b>					
Name	CPU2				
Manufacturer	[Redacted]				
Model	[Redacted]				
CPU ID	10-D0-1F-48-00-00-00-00				
Clock Speed	2600 MHz				
Cores/Threads	48 cores/48 threads				
L1/L2/L3 Cache	6144/24576/49152 KB				
Status	Enabled				
BOM Code	-				
Serial Number	4E0205D302F07508				
Other Parameters	64-bit Capable  Multi-Core  Execute Protection  Enhanced Virtualization  Power/Performance Control				

----End

# 9 Support and Other Resources

---

## 9.1 Technical Support

### Technical Support Website

Technical documents are available on the technical support website: <https://e.huawei.com/>.

### Self-Service Platform and Community

Learn more about servers and communicate with experts at:

- [Huawei Server Information Self-Service Platform](#) for specific server product documentation.
- [Huawei server intelligent Q&A system](#) for quick learning about products.
- [Huawei Enterprise Support Community \(Server\)](#) for learning and discussion.

### News

For notices about product life cycles, warnings, and updates, visit [Product Bulletins](#).

### Cases

Learn about server applications at [Knowledge Base](#).

### Huawei Technical Support

If a fault persists after taking the above measures, contact technical support at your local Huawei office. If a local Huawei office is not available, contact Huawei technical support as follows:

- Enterprise customers:  
Send emails to [support\\_e@huawei.com](mailto:support_e@huawei.com) or visit [Global Service Hotline](#).

- Carriers  
Send emails to [support@huawei.com](mailto:support@huawei.com) or visit [Global TAC Information](#).

## 9.2 Maintenance Tools

**Table 9-1** lists the software tools required for routine maintenance of Huawei servers.

**Table 9-1** Software tools for routine maintenance

Tool	Server Model and Software Version	Description
FusionServer Tools SmartKit	See the <a href="#">FusionServer Tools 2.0 SmartKit User Guide</a> .	SmartKit contains tools required for operations such as batch deployment, maintenance, and upgrade of server devices. Download link: <a href="#">FusionServer Tools</a>

# A Appendix

---

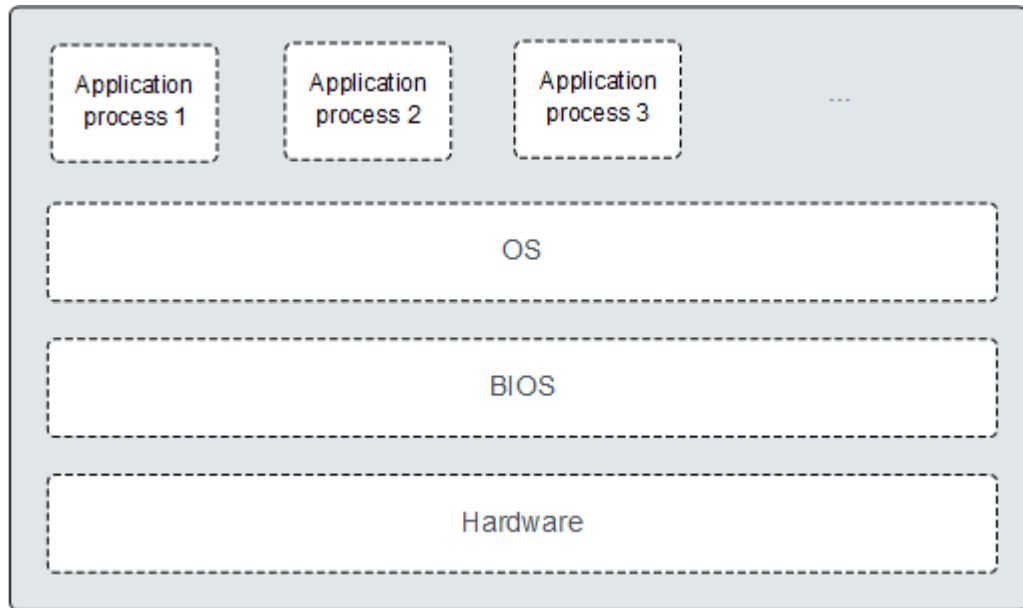
## A.1 BIOS

The basic input/output system (BIOS) is the most basic software loaded to a computer hardware system. It provides an abstraction layer between the computer hardware and the OS. It is used to perform hardware initialization during the boot process and provide runtime services for the OS and programs. [Figure A-1](#) shows the BIOS position in the system.

The BIOS data is stored on the Serial Peripheral Interface (SPI) flash memory. The BIOS performs a power-on self-test (POST), initializes CPU and memory, checks the I/O and boot device, and finally boots the OS. The BIOS also supports the advanced configuration and power interface (ACPI) and hot swap setting.

HUAWEI Kunpeng 920 platform server is a patented BIOS product with independent intellectual property rights. It supports customization and provides a variety of in-band and out-of-band configuration functions as well as high scalability.

**Figure A-1** BIOS in the system



For details, see the [BIOS Parameter Reference \(Kunpeng 920 Processor\)](#).

## A.2 iBMC

The iBMC is a Huawei proprietary intelligent management system that remotely manages servers.

The iBMC complies with Intelligent Platform Management Interface (IPMI) standards. It provides various functions, including keyboard, video, and mouse (KVM) redirection, text console redirection, remote virtual media, and reliable hardware monitoring and management.

The iBMC provides the following features:

- Multiple management interfaces for system integration  
The iBMC provides IPMI, CLI, Data Center Manageability Interface (DCMI), Redfish interfaces, Hypertext Transfer Protocol Secure (HTTPS), and SNMP.
- Fault detection and alarm management  
The iBMC implements fault detection and alarm management, ensuring stable, uninterrupted 24/7 system operation.
- Virtual KVM and virtual media  
The iBMC provides virtual KVM and virtual media, facilitating remote maintenance.
- WebUI  
The iBMC provides a web-based UI for setting and querying device information.
- System breakdown screenshots and video playback  
The iBMC allows screenshots and videos to be created when the system breaks down. The screenshots and videos help to identify the cause of system breakdown.



- **Screen snapshots and videos**  
The iBMC offers screen snapshots and videos, which simplify routine preventive maintenance, recording, and auditing.
- **Support for DNS and LDAP**  
The iBMC supports domain name system (DNS) and Lightweight Directory Application Protocol (LDAP) to implement domain management and directory service.
- **Active/standby backup**  
The iBMC works in active/standby mode to ensure system reliability. If the active iBMC is faulty, the standby iBMC takes over services immediately.

For more information about the iBMC, see the [TaiShan Rack Server iBMC User Guide](#).

## A.3 Glossary

### B

**BMC** baseboard management controller  
The BMC complies with the Intelligent Platform Management Interface (IPMI) standard, responsible for collecting, processing, and storing sensor signals, and monitoring the operating status of each component. The BMC provides the hardware status and alarm information about the managed objects for the management module, so that the management module can manage the objects.

### E

**Ethernet** A baseband local area network (LAN) architecture developed by Xerox Corporation in cooperation with DEC and Intel. Ethernet uses Carrier Sense Multiple Access/Collision Detection (CSMA/CD) and supports a data transfer rate of 10 Mbps on multiple cables. The Ethernet specification is the basis for the IEEE 802.3 standard.

### G

**Generic Routing Encapsulation (GRE)** Generic Routing Encapsulation is an internet based term applied to the encapsulation of IP datagrams tunneled through the internet. Generic Routing Encapsulation (GRE) is a mechanism for encapsulating any network layer protocol over any other network. GRE serves as a Layer 3 tunneling protocol, and provides a tunnel for transparently transmitting data packets.

### H

**hot swap** In a running system, insertion or removal of a component does not affect normal running of the system.

### K

**KVM** keyboard, video, and mouse

## M

**mezzanine card** A card connected to the mainboard through the connector, level to the mainboard. It is used on a device which has high requirement for space usage.

## P

**panel** The front-most or rear most element of a server, which serves to mount components, such as handles, indicators, and ports, and also seals the front of the chassis for airflow and electromagnetic compatibility (EMC).

**PCIe** A computer expansion bus standard based on the existing PCI programming and communication standards and a faster serial communication system. Intel is a major contributor to this standard. PCIe is used only for interconnection between applications. A PCI system can be turned into a PCIe one by modifying the physical layer instead of software. PCIe delivers a faster speed and can replace almost all existing bus standards including AGP and PCI.

## R

**RAID** redundant array of independent disks

A storage technology that combines multiple drives into a logical unit in several ways called "RAID levels", providing redundancy and delivering higher storage performance than a single disk.

**redundancy** The ability of a system to keep functioning normally in the event of a device failure by having a backup device automatically replace the faulty one.

## S

**system event log (SEL)** A non-volatile storage area and associated interfaces for storing system platform events for later retrieval.

**server** A special computer that provides various services for clients over a network.

## U

**U** A unit defined in International Electrotechnical Commission (IEC) 60297-1 to measure the height of a cabinet, chassis, or subrack. 1 U = 44.45 mm = 1.75 in.

## A.4 Acronyms and Abbreviations

### A

**AC** alternating current

### B

**BIOS** Basic Input/Output System

**BMC** Baseboard Management Controller

### C

**CLI** command-line interface

### D

**DC** direct current

**DDR4** Double Date Rate 4

**DDDC** Double Device Data Correction

**DIMM** dual in-line memory module

**DRAM** dynamic random access memory

**DVD** digital video disc

### E

**ECC** Error Checking and Correcting

### F

**FC** Fibre Channel

**FCC** Federal Communications Commission

**FTP** File Transfer Protocol

### G

**GE** Gigabit Ethernet

**GPU** Graphics Processing Unit

### H

**HA** High Availability

**HDD** hard disk drive

**HPC** High Performance Computing

<b>HTTP</b>	Hypertext Transfer Protocol
<b>HTTPS</b>	Hypertext Transfer Protocol Secure
<b>I</b>	
<b>iBMC</b>	Intelligent Baseboard Management Controller
<b>IEC</b>	International Electrotechnical Commission
<b>IOPS</b>	input/output operations per second
<b>IP</b>	Internet Protocol
<b>IPMB</b>	Intelligent Platform Management Bus
<b>IPMI</b>	Intelligent Platform Management Interface
<b>K</b>	
<b>KVM</b>	keyboard, video, and mouse
<b>L</b>	
<b>LRDIMM</b>	load-reduced dual in-line memory module
<b>LED</b>	light emitting diode
<b>LOM</b>	LAN on motherboard
<b>M</b>	
<b>MAC</b>	Media Access Control
<b>N</b>	
<b>NBD</b>	next business day
<b>NC-SI</b>	Network Controller Sideband Interface
<b>P</b>	
<b>PCIe</b>	Peripheral Component Interconnect Express
<b>PDU</b>	power distribution unit
<b>PHY</b>	physical layer
<b>PXE</b>	Preboot Execution Environment
<b>Q</b>	
<b>QPI</b>	QuickPath Interconnect
<b>R</b>	
<b>RAID</b>	redundant array of independent disks

<b>RAS</b>	Reliability, Availability and Serviceability
<b>RDIMM</b>	registered dual in-line memory module
<b>RJ45</b>	Registered Jack 45
<b>RoHS</b>	Restriction of the Use of Certain Hazardous Substances in Electrical and Electronic Equipment
<b>S</b>	
<b>SAS</b>	Serial Attached Small Computer System Interface
<b>SATA</b>	Serial Advanced Technology Attachment
<b>SNMP</b>	Simple Network Management Protocol
<b>SOL</b>	Serial Over LAN
<b>SSD</b>	solid-state drive
<b>T</b>	
<b>TCG</b>	Trusted Computing Group
<b>TCM</b>	Trusted Cryptography Module
<b>TCO</b>	Total Cost of Ownership
<b>TDP</b>	Thermal Design Power
<b>TET</b>	Trusted Execution Technology
<b>TFM</b>	Trans Flash Module
<b>TFTP</b>	Trivial File Transfer Protocol
<b>TPM</b>	Trusted Platform Module
<b>U</b>	
<b>UEFI</b>	Unified Extensible Firmware Interface
<b>UID</b>	unit identification light
<b>UL</b>	Underwriter Laboratories Inc.
<b>USB</b>	universal serial bus
<b>V</b>	
<b>VGA</b>	Video Graphics Array
<b>VLAN</b>	virtual local area network

## A.5 Sensor List (Server Configured with the Kunpeng 920 7260, 5250, or 5230 Processor)

Sensor	Description	Component
Inlet Temp	Air inlet temperature	Right mounting ear
Outlet Temp	Air outlet temperature	iBMC card
CPU/ <i>N</i> Core Rem	CPU core temperature	CPU. <i>N</i> indicates the CPU number. The value ranges from <b>1</b> to <b>2</b> .
CPU/ <i>N</i> Prochot	CPU Prochot	
CPU/ <i>N</i> VDDQ Temp	CPU VDDQ temperature	CPU 1: Components in positions U1 on the mainboard. CPU 2: Components in positions U2 on the mainboard. <i>N</i> indicates the CPU number. The value ranges from <b>1</b> to <b>2</b> .
CPU/ <i>N</i> VRD Temp	CPU VRD temperature	CPU 1: Components in positions U1 on the mainboard. CPU 2: Components in positions U2 on the mainboard. <i>N</i> indicates the CPU number. The value ranges from <b>1</b> to <b>2</b> .
CPU/ <i>N</i> MEM Temp	CPU DIMM temperature	DIMMs of CPU/ <i>N</i> . <i>N</i> indicates the CPU number. The value ranges from <b>1</b> to <b>2</b> .
Disk/ <i>N</i> Temp	SSD temperature	<i>N</i> indicates the physical drive slot number.
FAN/ <i>N</i> Speed	Fan speed sensor	Fan module. <i>N</i> indicates the fan module number. The value ranges from <b>1</b> to <b>4</b> .
Power	Server input power	Total PSU power.
Power/ <i>N</i>	PSU input power	PSU. <i>N</i> indicates the PSU number. The value is <b>1</b> or <b>2</b> .
CPU/ <i>N</i> Status	CPU status	CPU. <i>N</i> indicates the CPU number. The value ranges from <b>1</b> to <b>2</b> .

Sensor	Description	Component
CPU/ <i>N</i> Memory	DIMM status	DIMMs of CPU/ <i>N</i> . <i>N</i> indicates the DIMM number. The value ranges from <b>1</b> to <b>2</b> .
PSU/ <i>N</i> Fan Status	PSU fan status	PSU. <i>N</i> indicates the PSU number. The value is <b>1</b> or <b>2</b> .
PSU/ <i>N</i> Temp Status	PSU presence	
PSU/ <i>N</i> Status	PSU status	
Power Button	Power button status	Right mounting ear
UID Button	UID button status	
DISK/ <i>N</i>	Drive status	Drive. <i>N</i> indicates the physical drive slot number.
FAN/ <i>N</i> Presence	Fan presence	Fan module. <i>N</i> indicates the fan module number. The value ranges from <b>1</b> to <b>4</b> .
FAN/ <i>N</i> Status	Fan status	
RTC Battery	RTC battery status. An alarm is generated when the voltage is lower than 1 V.	CMOS battery
DIMM/ <i>N</i>	DIMM status	DIMM. <i>N</i> indicates the DIMM slot number.
PSU/ <i>N</i> Inlet Temp	PSU air inlet temperature	PSU. <i>N</i> indicates the PSU number. The value is <b>1</b> or <b>2</b> .
PSU/ <i>N</i> Redundancy	Redundancy failure due to PSU removal	
BMC Boot Up	BMC startup events	N/A <i>N</i> indicates the number of the component.
SEL Status	SEL full or clearing events	
Op. Log Full	Operation log full or clearing events	
Sec. Log Full	Security log full or clearing events	
CPU Usage	CPU usage	
Memory Usage	Memory usage	
BMC Time Hopping	Time hopping	
NTP Sync Failed	NTP synchronization failure and recovery events	

Sensor	Description	Component
Host Loss	System monitoring software (BMA) link loss detection	
SYS 12V_2	Mainboard 12.0 V voltage (the second output 12 V voltage detection for soft-start (riser module + NIC0 module))	
SYS 12V_3	Mainboard 12.0 V voltage (the third output 12 V voltage detection for soft-start (CPU1 + fan module))	
SYS 12V_4	Mainboard 12.0 V voltage (the third output 12 V voltage detection for soft-start (CPU2 + fan module))	
SYS 12V_5	Mainboard 12.0 V voltage (the fifth output 12 V voltage detection for soft-start (built-in drive backplane + CPU 2))	
SYS 12V_6	Mainboard 12.0 V voltage (the sixth output 12 V voltage detection for soft-start (front-drive backplane))	
CPU/VDDQ_AB	CPU memory voltage	
CPU/VDDQ_CD		
CPU/VRD Temp	CPU VRD voltage	
CPU/VDDAVS	CPU VDDAVS voltage	
CPU/HVCC	CPU HVVC voltage	
CPU/N_VDDAVS	CPU N_VDDAVS voltage	
CPU/VDDFIX	CPU VDDFIX voltage	
SAS Cable	Entity presence	
PSM/VIN	Input voltage	
PwrOk Sig. Drop	Voltage dip status	



Sensor	Description	Component
ACPI State	ACPI status	
SysFWProgress	Software process and system startup errors	
SysRestart	System restart causes	
Boot Error	Boot error	
Watchdog2	Watchdog	
Mngmnt Health	Management subsystem health status	
Riser <i>N</i> Card	Entity presence	
RAID Presence	Whether the RAID controller card is installed	
RAID <i>N</i> Temp	Temperature of the RAID controller card	
PCIe Status	PCIe status	
PwrOn TimeOut	Power-on timeout	
PwrCap Status	Power capping status	
HDD Backplane	Drive backplane entity presence	
HDD BP Status	Drive backplane health status	
NIC <i>N</i> Temp	Temperature of the NIC	
NIC OM Temp	OM temperature of the NIC	
NIC1- <i>N</i> Link Down ( <i>N</i> 1. 2. 3. 4 )	Network port link status of NIC 1	
NIC2- <i>N</i> Link Down ( <i>N</i> 1. 2. 3. 4 )	Network port link status of NIC 2	
System Notice	Hot restart reminder and fault diagnosis program information collection	
System Error	System suspension or restart. Check the background logs	

## A.6 Sensor List (Server Configured with the Kunpeng 920 5220 or 3210 Processor)

Sensor	Description	Component
Inlet Temp	Air inlet temperature	Right mounting ear
Outlet Temp	Air outlet temperature	iBMC card
CPU/ <i>N</i> Core Rem	CPU core temperature	CPU. <i>N</i> indicates the CPU number. The value is 1 or 2.
CPU/ <i>N</i> Prochot	CPU Prochot	
CPU/ <i>N</i> VDDQ Temp	CPU VDDQ temperature	CPU 1: Components in positions U1 on the mainboard. CPU 2: Components in positions U2 on the mainboard. <i>N</i> indicates the CPU number. The value is 1 or 2.
CPU/ <i>N</i> VRD Temp	CPU VRD temperature	CPU 1: Components in positions U1 on the mainboard. CPU 2: Components in positions U2 on the mainboard. <i>N</i> indicates the CPU number. The value is 1 or 2.
CPU/ <i>N</i> MEM Temp	CPU DIMM temperature	DIMMs of CPU/ <i>N</i> . <i>N</i> indicates the CPU number. The value is 1 or 2.
Disks Temp	Highest temperature among the temperature of all drives	-
FAN/ <i>N</i> Speed	Fan speed sensor	Fan module. <i>N</i> indicates the fan module number. The value ranges from 1 to 4.
Power	Server input power	Total PSU power
Power/ <i>N</i>	PSU input power	PSU. <i>N</i> indicates the PSU number. The value is 1 or 2.
CPU/ <i>N</i> Status	CPU status	CPU. <i>N</i> indicates the CPU number. The value is 1 or 2.

Sensor	Description	Component
CPU/ <i>N</i> Memory	DIMM status	DIMMs of CPU/ <i>N</i> . <i>N</i> indicates the DIMM number. The value is <b>1</b> or <b>2</b> .
PS/ <i>N</i> Fan Status	PSU fan status	PSU. <i>N</i> indicates the PSU number. The value is <b>1</b> or <b>2</b> .
PS/ <i>N</i> Temp Status	PSU presence	
PS/ <i>N</i> Status	PSU status	
Power Button	Power button status	Right mounting ear
UID Button	UID button status	
DISK/ <i>N</i>	Drive status	Drive. <i>N</i> indicates the physical drive slot number.
FAN/ <i>N</i> Presence	Fan presence	Fan module. <i>N</i> indicates the fan module number. The value ranges from <b>1</b> to <b>4</b> .
FAN/ <i>N</i> Status	Fan status	
RTC Battery	RTC battery status. An alarm is generated when the voltage is lower than 1 V.	CMOS battery
DIMM/ <i>N</i>	DIMM status	DIMM. <i>N</i> indicates the DIMM slot number.
PS/ <i>N</i> Inlet Temp	PSU air inlet temperature	PSU. <i>N</i> indicates the PSU number. The value is <b>1</b> or <b>2</b> .
PS Redundancy	Redundancy failure due to PSU removal	PSU
BMC Boot Up	BMC startup events	N/A. <i>N</i> indicates the component ID.
SEL Status	SEL full or clearing events	
Op. Log Full	Operation log full or clearing events	
Sec. Log Full	Security log full or clearing events	
CPU Usage	CPU usage	
Memory Usage	Memory usage	
BMC Time Hopping	Time hopping	
NTP Sync Failed	NTP synchronization failure and recovery events	

Sensor	Description	Component
Host Loss	System monitoring software (BMA) link loss detection	
SYS 12V_1	Mainboard 12.0 V voltage (the second output 12 V voltage detection for soft-start (fan module))	
SYS 12V_2	Mainboard 12.0 V voltage (the third output 12 V voltage detection for soft-start (CPU2 + rear-drive backplane))	
SYS 12V_3	Mainboard 12.0 V voltage (the fourth output 12 V voltage detection for soft-start (CPU1 + CPU2))	
SYS 12V_4	Mainboard 12.0 V voltage (the fifth output 12 V voltage detection for soft-start (front-drive backplane))	
SYS 12V_5	Mainboard 12.0 V voltage (the sixth output 12 V voltage detection for soft-start (NIC + riser card + RAID controller card + rear-drive backplane))	
CPU/VDDQ_AB	CPU memory voltage	
CPU/VDDQ_CD		
CPU/VRD Temp	CPU VRD voltage	
CPU/VDDAVS	CPU VDDAVS voltage	
CPU/VDDFIX	CPU VDDFIX voltage	
SAS Cable	Entity presence	
PSM/VIN	Input voltage	
PwrOk Sig. Drop	Voltage dip status	
ACPI State	ACPI status	

Sensor	Description	Component
SysFWProgress	Software process and system startup errors	
SysRestart	System restart causes	
Boot Error	Boot error	
Watchdog2	Watchdog	
Mngmnt Health	Management subsystem health status	
RiserN Card	Entity presence	
RAID Presence	Whether the RAID controller card is installed	
RAID Temp	Temperature of the RAID controller card	
PCIe Status	PCIe status	
PwrOn TimeOut	Power-on timeout	
PwrCap Status	Power capping status	
HDD Backplane	Drive backplane entity presence	
HDD BP Status	Drive backplane health status	
NICN Temp	Temperature of the NIC	
NIC OM Temp	OM temperature of the NIC	
NIC1-N Link Down (N 1. 2. 3. 4)	Network port link status of NIC 1	
NIC2-N Link Down (N 1. 2. 3. 4)	Network port link status of NIC 2	
System Notice	Hot restart reminder and fault diagnosis program information collection	
System Error	System suspension or restart. Check the background logs	
Cert OverDue	Certificate expiration check	
RTC time	RTC clock status	