

LF Edge Akraino Project 2021 Annual Review to LF Edge TAC

February 9th, 2022 Rev A

Ike Alisson

Akraino TSC member & Documentation Sub-committee TSC Chair



Contents

1. Akraino Overview
2. Akraino Internal Activities
3. Akraino External Activities
4. Questions



1. Akraino Overview - 1

- 20 < Blueprints (aka Integration Projects), BPs Proposals & Feature Projects
 - set of Open Infrastructures & Application Blueprints (BPs)
- Coordination & Co-operation with Multiple Upstream Open Source Communities/SDOs as:
 - Airship,
 - LFN Anuket
 - OpenStack,
 - LFN ONAP,
 - LFN EMCO,
 - ETSI MEC,
 - GSMA,
 - TIP,
 - CNCF
 - O-RAN

Objective: To deliver a fully integrated stack



What is Akraino? Everything About Edge – Akraino is the Edge Project

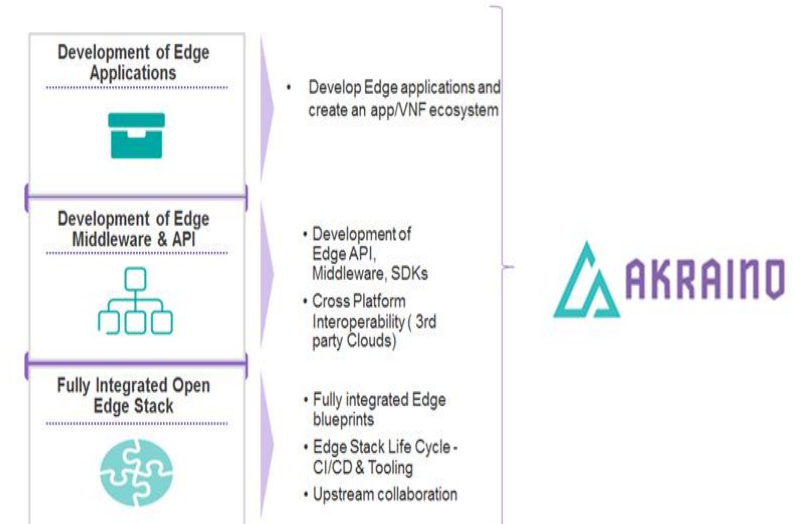

Deploy third party services such as



Or use built in tools

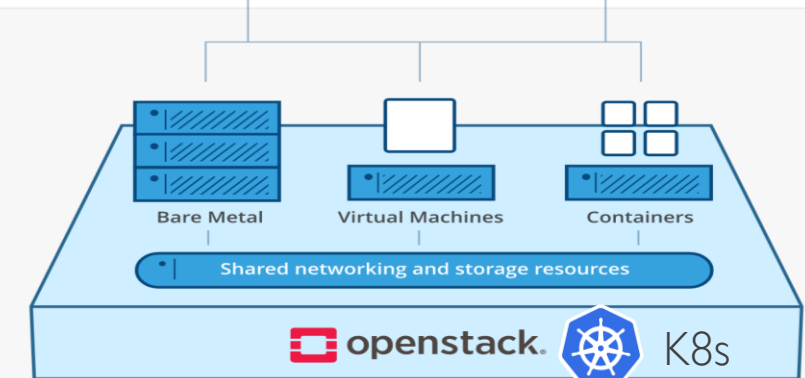
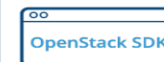

Akraino Project (Blueprint) Lifecycle States and Reviews phases

- Five (5) states that Projects goes through.
- A Project Lifecycle may **extend across** Multiple Projects & Akraino Releases
- The Procedure of moving from one (1) State to the next one is **independent from the Akraino Release Lifecycle** and the pace depends on each individual Project.
- In order to effectively review Project progress, **four (4) Reviews** are built-in to the Project Lifecycle, namely,
 1. Proposal,
 2. Incubation,
 3. Mature,
 4. Core
 5. Archived

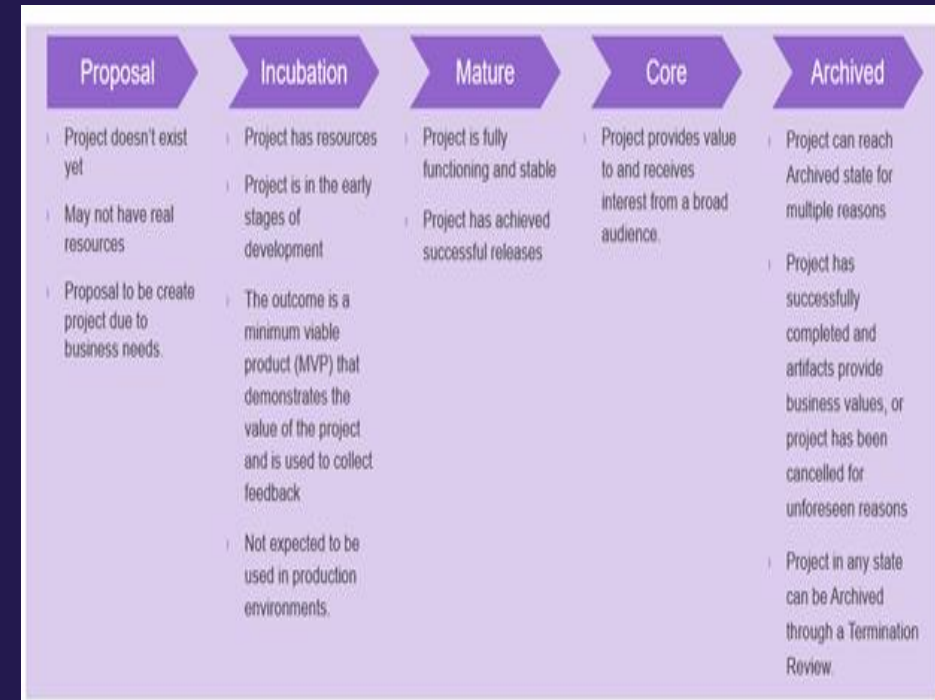

[Copy Short URL](#)
 Jump To Sections Within This Page:
 Source Control ▾
[Select Time Range \(Last 90 Days \)](#)

SOURCE CONTROL

Commits

[Go To Overview](#)

[Select Time Range \(Last 90 Days \)](#)

SOURCE CONTROL

Commits

[Go To Overview](#)



Top 10 Contributors By Commits [View All](#)

NAME	LINES OF CODE	COMMITTS	%
Todd Malsbary	13.44K	25	33.39%
Kuralamudhan R...	7.08K	11	17.60%
Eric Ball	144	5	0.36%
ashgit301	40	2	0.10%
Le Yao	2.34K	2	5.80%
Trevor Tao	4	1	0.01%
Anil Shashikumar...	8	1	0.02%
Andrew Grimberg	24	1	0.06%
palaniap	8.83K	1	21.94%

Top 10 Organizations By Commits [View All](#)

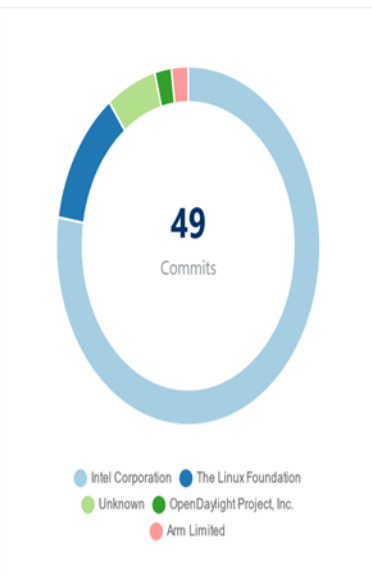

[Copy Short URL](#)
 Jump To Sections Within This Page:
 Source Control ▾
[Select Time Range \(Last 90 Days \)](#)

PULL REQUESTS / CHANGESETS

Gerrit GitHub

[Go To Overview](#)



Top 10 Contributors By Changesets [View All](#)

NAME	CHANGESETS	%
Todd Malsbary	48	63.16%
Kuralamudhan Ra...	11	14.47%
ashvin.p-REDACTE...	5	6.58%
Le Yao	2	2.63%
Patryk Strusiewicz-...	2	2.63%
Andrew Grimberg	1	1.32%
Anil Shashikumar ...	1	1.32%
Asif Mehmood	1	1.32%
Eric Ball	1	1.32%

Top 10 Organizations By Changesets [View All](#)

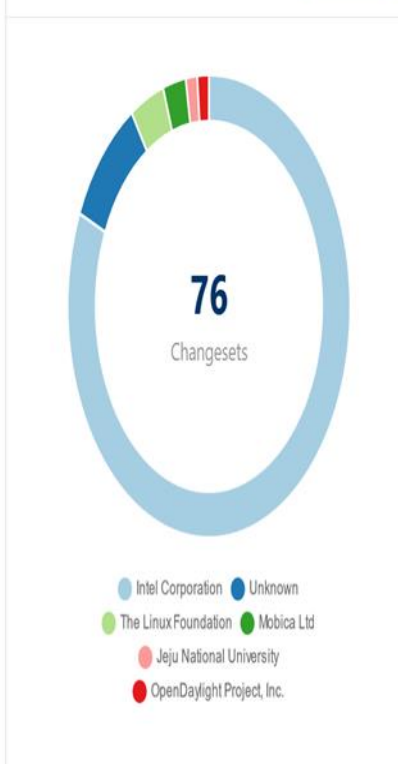

1. Akraino Overview- 4

All Projects > Linux Foundation Edge > Akraino (beta) > Technical Trends > Summary

Copy Short URL Jump To Sections Within This Page: Source Control Select Time Range (Last 90 Days)

SOURCE CONTROL

Commits

Go To Overview

SOURCE CONTROL

Commits

Go To Overview

41.38K Lines Of Code Changed

Top 10 Contributors By Commits [View All](#)

NAME	LINES OF CODE	COMMITTS	%
arvindpatel	12.12K	64	29.2
Ricardo Noriega	5.62K	18	13.5
khemendra kum...	5.10K	11	12.3
Todd Malsbary	955	10	2.3
Gaurav Agrawal	14.19K	7	34.3
Kuralamudhan R...	367	7	0.8
Oleg Berzin	1.24K	5	3.0
Srinivasan Selvam	505	3	1.2

Top 10 Companies By Commits [View All](#)

161 Commits

- Huawei Technologies Co., Ltd.
- Red Hat
- Intel Corporation
- AT&T Services, Inc.
- Equinix
- The Linux Foundation
- Salesforce.com
- ARM
- China Mobile Communication Company Ltd

Top 10 Contributors By Commits [View All](#)

NAME	LINES OF CODE	COMMITTS	%
arvindpatel	12.12K	64	8.62%
Kuralamudhan R...	8.69K	27	6.18%
Xinhui Li	83.20K	23	59.17%
Ricardo Noriega	5.86K	22	4.17%
Todd Malsbary	1.04K	19	0.74%
khemendra kum...	6.74K	17	4.79%
Srinivasan Selvam	3.28K	12	2.33%
Yao Le	1.72K	9	1.22%
Gaurav Agrawal	14.19K	7	10.00%

No Of Sub Projects

1

Repositories

19

All Projects > Linux Foundation Edge > Akraino (beta) > Technical Trends > Summary

Get Short URL Jump To Sections Within This Page: Source Control Select Time Range (Last 6 Months)

SOURCE CONTROL

Commits

Go To Overview

140.61K Lines Of Code Changed

Top 10 Organizations By Commits [View All](#)

252 Commits

- Huawei Technologies Co., Ltd.
- Intel Corporation
- Red Hat
- AT&T Services, Inc.
- Salesforce.com
- The Linux Foundation
- Equinix
- ARM
- China Mobile Communication Company Ltd
- Others

Commits

252

Contributors

22

No Of Sub Projects

1

Repositories

21





03/01/2021 - 03/03/2021 Akraino Technical Meetings - Spring

Summary

- > Agenda:- R5 planning, 2021 priorities for the community, labs, developer sync-up
- > Dates: March 1st to 3rd, 2021

> All the time mentioned here is PT, California time.

> Register for the event at <https://events.linuxfoundation.org/akraino-technical-meetings-spring/>

> Speakers please upload the presentation before the meeting starts.

> Akraino PowerPoint/Google Slides Template

Meeting Agenda Lead: @Tina Tsou, Akraino TSC Chair

Please submit any questions about this event to tsc@lists.akraino.org in the #akraino channel on <https://slack.lfedge.org/>

Meeting Recordings

- **Day 1:** https://zoom.us/rec/share/a-t4W7MZJjVP7_D3o505OkbPX7SQg9BHIPuMP2cJat5Z3dN-ZhqESojOTRYHV8Gm.RlueAB0KcgFBEikB?startTime=1614609817000 (Part 1)
- https://zoom.us/rec/share/a-t4W7MZJjVP7_D3o505OkbPX7SQg9BHIPuMP2cJat5Z3dN-ZhqESojOTRYHV8Gm.RlueAB0KcgFBEikB?startTime=1614641824000 (Part 2)
- **Day 2:** https://zoom.us/rec/share/uiBs_eUEkdKiEPMY-pkdCs1xytBvweEMjTMx64YfUEmHuumU07Hf8TWI2gyXTiJi.OwXZyKbSqOQFprpj?startTime=1614696618000
- **Day 3:** https://zoom.us/rec/share/_wcuUiNydsIG2o5IBeriDRKy6ZsdT68o5wSI7TNjgm4BXN9Yj2n9-

Tuesday, 2021-mar-02

Meeting Location: Zoom ([https://zoom.us/j/97031339119?pwd=U2FXM1RJU1BvRGFvOUt5dDZaTmp2Zz09](https://zoom.us/j/97031339119?pwd=U2FXM1RJU1BvRGFvOUt5dDZaTmp2Zz09Passcode:134822) Passcode: 134822)

Meeting Recording - Day 2: https://zoom.us/rec/share/uiBs_eUEkdKiEPMY-pkdCs1xytBvweEMjTMx64YfUEmHuumU07Hf8TWI2gyXTiJi.OwXZyKbSqOQFprpj?startTime=1614696618000

Time	Topics
7:15 am - 7:45 am	TSC Members Sharing Technical Steering Committee (TSC) 2020-2021
7:45 am - 8:05 am	Open Source Networking, Edge, and Access - Arpit Joshipura, Linu Foundation





09/22/2021 - 09/24/2021 Akraino Technical Meetings - Fall

Summary

- > Agenda:- R6 planning, 2021 priorities for the community, labs, developer sync-up
- > Dates: September 22nd to 24th, 2021
- > All the time mentioned here is PT, California time.

WEDNESDAY, SEPTEMBER 22 (North America time zone friendly)

09:00 – 10:30 PDT (UTC-7) 12:00 – 13:30 EDT (UTC-4) 18:00 – 19:30 CEST (UTC+2) 00:00 – 01:30 CST (UTC+8) (Thursday)	Keynote Sessions
10:30 – 10:45 PDT (UTC-7) 13:30 – 13:45 EDT (UTC-4) 19:30 – 19:45 CEST (UTC+2) 01:30 – 01:45 CST (UTC+8) (Thursday)	Break
10:45 – 12:00 PDT (UTC-7) 13:45 – 15:00 EDT (UTC-4) 19:45 – 21:00 CEST (UTC+2) 01:45 – 03:00 CST (UTC+8) (Thursday)	Keynote Sessions Resume

THURSDAY, SEPTEMBER 23 (APAC time zone friendly)



18:00 – 19:30 PDT (UTC-7) 21:00 – 22:30 EDT (UTC-4) 03:00 – 04:30 CEST (UTC+2) (Friday) 09:00 – 10:30 CST (UTC+8) (Friday)	Keynote Sessions
19:30 – 19:45 PDT (UTC-7) 22:30 – 22:45 EDT (UTC-4) 04:30 – 04:45 CEST (UTC+2) (Friday) 10:30 – 10:45 CST (UTC+8) (Friday)	Break
19:45 – 21:00 PDT (UTC-7) 22:45 – 24:00 EDT (UTC-4) 04:45 – 06:00 CEST (UTC+2) (Friday) 10:45 – 12:00 CST (UTC+8) (Friday)	Keynote Sessions Resume

Thursday, 2021-sep-23

Meeting Location: Zoom: <https://zoom.us/j/96204631964?pwd=RGZBZmdoUnhadjdkSUJZekxHMnVpUT09>

Meeting Recording - Day 2: https://zoom.us/rec/share/ebe8WfCM8LcOasRr8GR_I0hwUVcpl4-pNxgwBCInLe87E_VRIe-lwXmcGnPGnM70.8oUQ8K8g7gzm3tuu?startTime=1632444412000

Time Zone: All times below are US Pacific Time Zone

Time	Topics
6:15 pm - 6:30 pm	Edge AI Cloud Native Brief Introduction @ .叶王 (Wang Ye), Baidu 
6:30 pm - 6:40 pm	IoT/edge social implementation example @ Fukano Haruhisa , Yamada Kenji, Fujitsu 



Akraino R5+ Blueprints

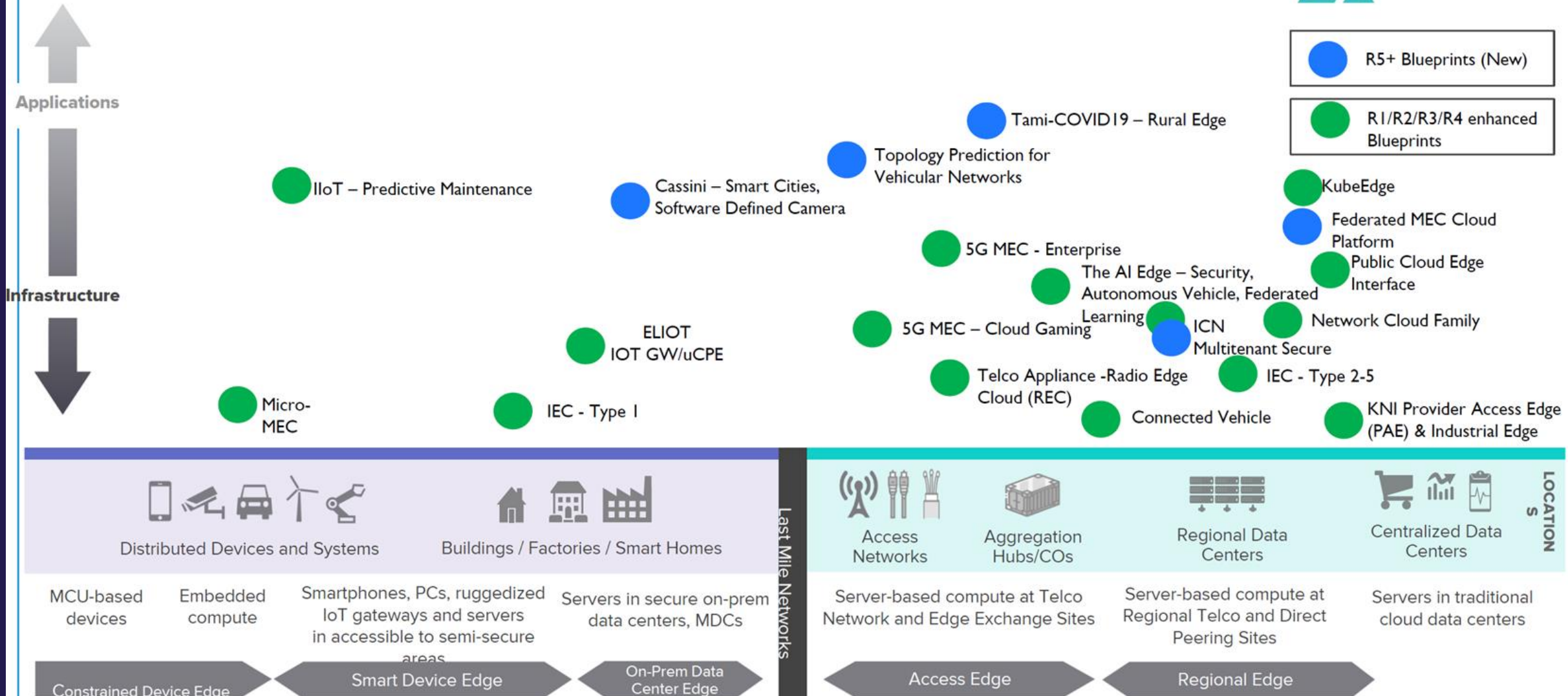

New Blueprints for R5



Smart Cities

[Read More](#)



**MEC-based Stable
Topology Prediction for
Vehicular Networks**



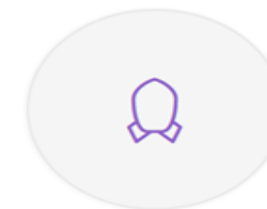

















[Read More](#)



**Multitenant Secure Cloud
Native platform (ICN-
MTSCN)**

[Read More](#)

R5 Updates to Existing Blue Prints

 <p>Connected Vehicles</p> <p>Read More</p>	 <p>IEC Type 4: AR/VR oriented Edge Stack for Integrated Edge Cloud (IEC) Blueprint Family</p> <p>Read More</p>	 <p>ICN – Integrated Cloud-Native Family</p> <p>Read More</p>	 <p>ELIOT IoT Gateway Blueprint</p> <p>Read More</p>	 <p>ELIOT SD-WAN/WAN Edge/uCPE Blueprint</p> <p>Read More</p>	 <p>Network Cloud and TF (Tungsten Fabric) Integration Project Network Cloud and TF (Tungsten Fabric) Integration Project</p> <p>Read More</p>	 <p>KNI Provider Access Edge</p> <p>Read More</p>	 <p>KNI Industrial Edge</p> <p>Read More</p>
 <p>The AI Edge: School/Education Video Security Monitoring</p> <p>Read More</p>	 <p>The AI Edge: Intelligent Vehicle-Infrastructure Cooperation System (I-VICS)</p> <p>Read More</p>	 <p>5G MEC/Slice System to Support Cloud Gaming, HD Video and Live Broadcasting Blueprint</p> <p>Read More</p>	 <p>IEC Type 3: Android cloud native applications on Arm servers in edge for Integrated Edge Cloud (IEC) Blueprint Family</p> <p>Read More</p>	 <p>IEC Type 5: SmartNIC for Integrated Edge Cloud (IEC) Blueprint Family</p> <p>Read More</p>	 <p>Enterprise Applications on Lightweight 5G Telco Edge</p> <p>Read More</p>	 <p>Public Cloud Edge Interface (PCEI) Blueprint Public Cloud Edge Interface (PCEI) Blueprint</p> <p>Read More</p>	 <p>IoT Workloads at the Smart Device Edge – Predictive Maintenance (with a Thermal Imaging Camera, vibration sensors, etc.)</p> <p>Read More</p>
 <p>The AI Edge: Federated ML application at edge</p> <p>Read More</p>	 <p>KubeEdge Edge Service Blueprint</p> <p>Read More</p>	 <p>Private LTE/5G ICN Blueprint</p> <p>Read More</p>	 <p>IEC Type 2 for Integrated Edge Cloud (IEC) Blueprint Family</p> <p>Read More</p>				



09/28/2021 Akraino R5 Webinar: Expanding the Edge

Skapad av Tina Tsou, senast ändrad av Asif Mehmood den sep 28, 2021

VIRTUAL SCHEDULE AT-A-GLANCE

Tuesday, SEPTEMBER 28

09:00 – 10:00 PDT (UTC-7)
12:00 – 13:00 EDT (UTC-4)
18:00 – 19:00 CEST (UTC+2)
00:00 – 01:00 CST (UTC+8) (*Thursday*)

Date Time: Sep 28, 2021 09:00 AM Pacific Time (US and Canada)

Topic: Akraino R5: Expanding the Edge

Here is the link to register for the webinar -- please share this with your friends and colleagues: https://zoom.us/webinar/register/WN_xnujjXiTJa9irf9h0_rrw

Description: Akraino is an open source software stack that improves the state of edge cloud infrastructure for carrier, provider, and IoT networks. It offers new levels of flexibility to scale edge cloud services quickly, to maximize the applications or subscribers supported on each server, and to help ensure the reliability of systems that must be up at all times.

Join the community for a webinar outlining the newest blue prints available in the latest release, Akraino R5, covering new uses cases for:

Akraino R5

Tina Tsou, , TSC Chair, Akraino

Oleg Brezin, TSC co-chair, Akraino

LF EDGE

THE LINUX FOUNDATION



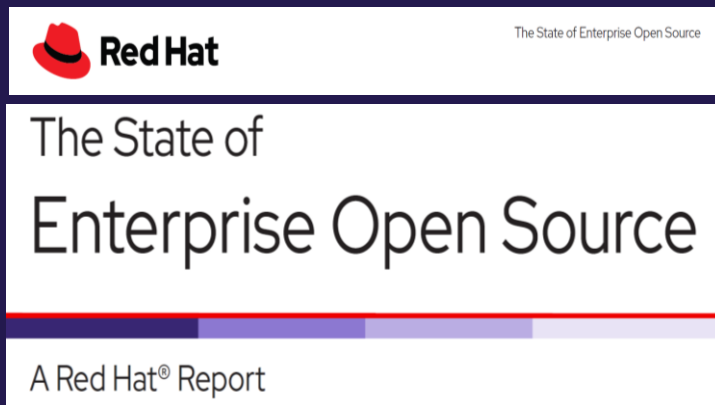

In a stand-out finding of interest to our Telco Customers, 95% of respondents from the Telecommunications Industry report using Open Source.

The high-level takeaway of the report is that: "using Open Source SW across all Industries is no longer principally about making best use of IT Budgets.

Lower Cost of Ownership has fallen off the top spot and now sits in sixth (6th) position.

Today, the Strategic Benefits of using Open Source are valued more, including:

Top benefits of using enterprise open source

1. Higher quality software **35%**
2. Access to latest innovations **33%**
3. Better security **30%**
4. Ability to safely leverage open source technologies **30%**

Top benefits of using enterprise open source

U.S.	EMEA	APAC	LATAM
35% Higher quality software	35% Higher quality software	38% Higher quality software	35% Better security
33% Access to latest innovations	33% Access to latest innovations	33% Access to latest innovations	34% Higher quality software
32% Ability to safely leverage open source technologies	31% Better security	30% Trusted by smartest software engineers	32% Ability to safely leverage open source technologies
		30% Ability to safely leverage open source technologies	



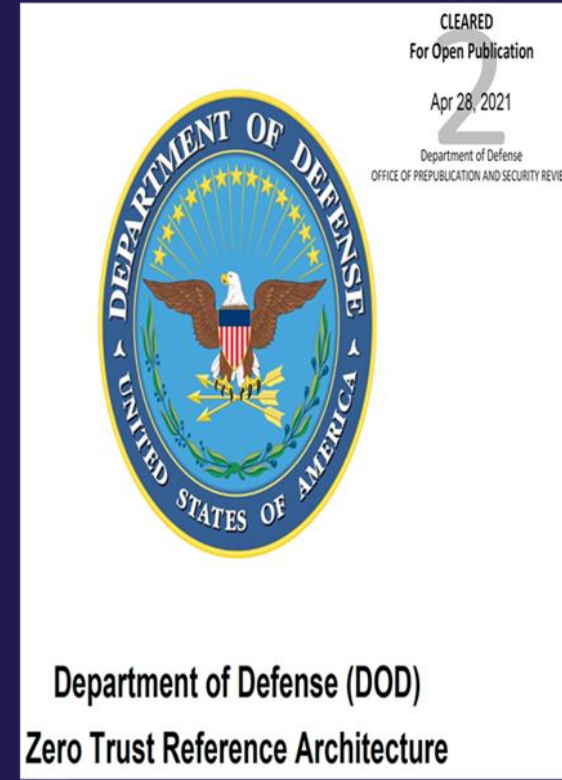
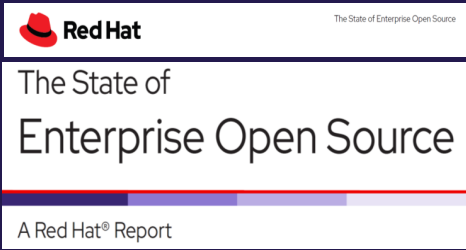

Akraino Edge Stack Security Sub-Committee

September 24, 2021

Daniil Egranov
Security Sub-Committee Co-Chair, Akraino

Randy Stricklin
Security Sub-Committee Chair, Akraino



Akraino Security Team 2021 Accomplishments

- › Automated Lynis, Vuls and Kube-Hunter Log Output Pass/Fail Analysis
- › Lynis – Reviewed Required Tests
 - › Formalized and Documented Lynis Incubation vs Maturity Requirements
- › Platform Security for Akraino Blueprints
 - › Arm
 - › x86
- › Release 4 and 5 Blueprint Reviews



Akraino Security Team Future Plans - 2022

- › Develop Minimum OS Version Support Document
 - › Ubuntu, CentOS, RHEL CoreOS, Debian
- › Develop Minimum Security Tool Version Support Document
 - › Lynis, Vuls, Kube-Hunter, and OVAL (Vuls) database
- › BluVal (Blueprint Validation):
 - › Integrate Automated Lynis, Vuls and Kube-Hunter Pass/Fail
 - › Enforce minimum versions of Vuls, Lynis and Kube-Hunter
- › Version 1.0 Platform Security Whitepaper
- › Investigate using LFX Security



Dashboard / ... / Akraino China Community

Akraino China Community - Downstream Lab 1 (China South, mainly Arm architecture initially)

Skapad av Tina Tsou, senast ändrad av yantao zhao den jan 21, 2022

- Cooperation mode
 - 1) Cooperation at the organizational level;
 - 2) Cooperative positioning
 - 3) Business implementation
 - 4) Industry promotion;
 - 5) Ability and personnel
 - 6) About GCC/ECC
- Blueprint Landing Plans
 - Integrated Edge Cloud (IEC) Blueprint Family
 - IEC Type 3: Android cloud native applications on Arm servers in edge for Integrated Edge Cloud (IEC) Blueprint Family
 - Products implementing the blueprint:
 - Industrial Conference:
 - Exhibition:
 - Target Industries:
 - IEC Type 5: SmartNIC for Integrated Edge Cloud (IEC) Blueprint Family
 - Products implementing the blueprint:
 - Industrial Conference:
 - Exhibition:
 - Target Industries:
 - Poster:
 - The AI Edge Blueprint Family

Dashboard / ... / Akraino China Community

Akraino China Community - Downstream Lab 2 (China North Architecture/Vendor Neutrality)

Skapad av Tina Tsou, senast ändrad den dec 08, 2021

Benefits all the architecture irrespective of ARM or X86. It benefit Akraino community as a well.

@Kuralamudhan Ramakrishnan @YEJI

02,Dec 2021

Derek Jee/SDNLAB/

Akraino and SDNLAB Collaboration.ppt

SDNLAB Introduction
jjee@sdnlab.com





Ting Zou (Tina Tsou) • 1st
Technical Executive Leadership
5mo • 🌐

View my verified achievement from The Linux Foundation.



Akraino Community Awards 2021 - Woman of the Year was issued by The Linux Foundation to Tina Tsou.



Oleg Berzin • 1st
Fellow, Technology and Architecture, Office of the CTO
6mo • 🌐

View my verified achievement from The Linux Foundation.



Akraino Community Awards 2021 - Top Blueprint of the Year was issued by The Linux Foundation to Oleg Berzin.

Kuralamudhan Ramakrishnan (He/Him) • 1st
Technical Lead at Intel Corporation | TSC member for Akraino LF Edge Comm...
6mo • 🌐

View my verified achievement from The Linux Foundation.



Akraino Community Awards 2021 - Top Blueprint of the Year was issued by The Linux Foundation to Kuralamudhan Ramakrishnan.



2. Akraino Internal Activities 10 - Akraino Annual Awards -2

Srinivasa Addepalli • 1st
Cloud/Edge/IOT Strategy and Software architecture
6mo • Edited •

View my verified achievement from The Linux Foundation.

Akraino/ICN BPs are winners this year :-)



Akraino Community Awards 2021 - Top Blueprint of the Year was issued by The Linux Foundation to Srinivasa Addepalli.

Prabhjot Singh Sethi • 2nd
VP Engineering @ CoreEdge.io
6mo • Edited •

Thank you Akraino community and The Linux Foundation for recognition of my work towards Private LTE/5G blueprint.



Akraino Community Awards 2021 - Top Blueprint of the Year was issued by The Linux Foundation to Prabhjot Sethi.

Yolanda Robla • 2nd
Staff Software Engineer at Miro.com
6mo •

View my verified achievement from The Linux Foundation.



Akraino Community Awards 2021 - Woman of the Year was issued by The Linux Foundation to Yolanda Robla Mota.

sandeep sharma • 2nd
Engineer at Aarna Networks, Inc.
6mo •

View my verified achievement from The Linux Foundation.



Akraino Community Awards 2021 - Top Blueprint of the Year was issued by The Linux Foundation to Sandeep Sharma.



Mehmet Toy, Ph.D • 2nd
Assoc. Verizon Fellow, Distinguished MEF Fellow, IEEE Life Sr. Member
6mo •

View my verified achievement from The Linux Foundation.



Akraino Community Awards 2021 - Top Blueprint of the Year was issued by The Linux Foundation to Mehmet Toy.

Amar Kapadia • 2nd
CRN 10 Hottest Edge Computing Startups 2022
6mo •

View my verified achievement from The Linux Foundation.



Akraino Community Awards 2021 - Top Blueprint of the Year was issued by The Linux Foundation to Amar Kapadia.

Ricardo Noriega de Soto • 2nd
Principal SW Engineer @ Emerging Technologies - Office of the CTO en Red ...
6mo •

View my verified achievement from The Linux Foundation.



Akraino Community Awards 2021 - Top Committer was issued by The Linux Foundation to Ricardo Noriega.

姚乐 • 2nd
英特尔 - Cloud Engineer
6mo •

View my verified achievement from The Linux Foundation.



Akraino Community Awards 2021 - Top Blueprint of the Year was issued by The Linux Foundation to Le Yao.

Raja Mittra • 3rd+
Lead Engineer Network at Rebeca Technologies
6mo •

View my verified achievement from The Linux Foundation.



Akraino Community Awards 2021 - Top Blueprint of the Year was issued by The Linux Foundation to Raja Mittra.





11/23/2021 Akraino Reunion Meeting

Skapad av Tina Tsou, senast ändrad av Jeff Brower den dec 09, 2021

IN PERSON & VIRTUAL SCHEDULE AT-A-GLANCE

When: Tuesday, November 23

10:30 – 14:30 PST (UTC-8)

13:30 – 17:30 EDT (UTC-5)

19:30 – 1:30 CET (UTC+1) *(Wednesday)*

02:30 – 6:30 CST (UTC+8) *(Wednesday)*

Date Time: Nov 23, 2021 10:30 AM - 2:30 PM PST (US and Canada)

Topic: Akraino Reunion Meeting

Where: HanaHaus + Blue Bottle Coffee

Address: 456 University Ave, Palo Alto, CA 94301

websites: [HanaHaus](#) (click on Palo Alto), [bluebottlecoffee.com](#)

Proposed / Working Agenda, subject to modification (please modify as needed)

1 2022 General Planning

1.1 How can we better promote and/or market Akraino strengths

1.1.1 Conduct technical meetups and seminar, create a template and apply it across the community (Kural)

1.1.2 Blueprint diversity (Jeff)

1.1.3 Co-existence of Hyperscalers and Telecoms (Jeff)

1.1.4 Blueprint release security requirements (Randy)

1.1.5 API database (API usage info gathering, API map, collaboration with ETSI MEC DECODE) (Jane, Oleg)

2 Discuss and identify key edge computing trends for 2022

3 Look for ways to increase standards compliance and encourage interoperability between blueprints (Ike)

4 Barnstorming ideas to increase Akraino participation and user contribution

3.1 Akraino China Community run by OpenGCC (Tina)

3.1.1 Discuss x86 pilot blueprint; for example, demonstrate x86 compatibility of GCC lab machines (Jeff)

3.2 TSC meetings increased participation – assign TSC members to recruit interesting "keynote speakers" for Tuesday
TSC members to recruit well, for example a small cash prize, points gained for next TSC election, etc (Jeff)

5 Existing Blueprint Areas

5.1 Automotive

6 New Blueprint Areas for 2022

4.1 Robotics (Jeff)

4.1.2 Fujitsu presentation (Fukano-san, 10:30a)

Introduction to SSES(Sensor-Rich Soft End-Effector System)





1. Use of ETSI MEC architecture in Akraino BPs. Some BPs already explicitly refer to ETSI MEC in their architecture (e.g., EALTEdge). Some BPs are “mappable” to ETSI MEC architecture (e.g. PCEI). Maybe we should include an optional architecture section in BP architecture documents that shows the alignment with ETSI MEC.
2. Direct implementation of ETSI MEC services and APIs in Akraino BPs
3. Participation in ETSI MEC Hackathons and/or Plugtests. Akraino BPs and releases are essentially a “continuous hackathon”. Given that many Akraino BPs provide solutions for Edge Computing, we should find a way to “channel” Akraino BPs as ETSI MEC hackathon projects as well.
4. Include MEC specs in LF Edge Akraino API map, using either the existing Blueprint-organized map or a different basis of organization
5. Conduct architectural mapping and analysis between sample Akraino Blueprint projects (For example, PCEI) and appropriate MEC reference architecture
6. Promote MEC APIs in Akraino Blueprint projects, specifically MEC009 API design generic **guidelines**
7. Map, analyze, and compare Akraino Federated edge projects with MEC Federation specifications
8. Focus on implementing specific MEC use case categories (e.g., IoT, URLLC, Vehicular) in Akraino BPs



ETSI MEC Update of the collaborations with OpenSource, with special focus on LF Edge Akraino

Presented by: **Jane Shen,**
VP of Technology Strategy, Mavenir
Technical Expert, ETSI MEC ISG

© ETSI 2021

15.11.2021





The OPG believes that, for Operators to develop a Federated Edge Computing Platform such as the OP, Requirements must be enforceable in Contracts by a Published Set of Standards.

To this end, the OPG proposes selecting ETSI ISG MEC and 3GPP to provide a Standard Reference for an Edge Service End to End (E2E) definition.

We note that 3GPP EDGEAPP Architecture and ETSI ISG MEC Architecture could complement each other in a way that is acceptable to OPG:

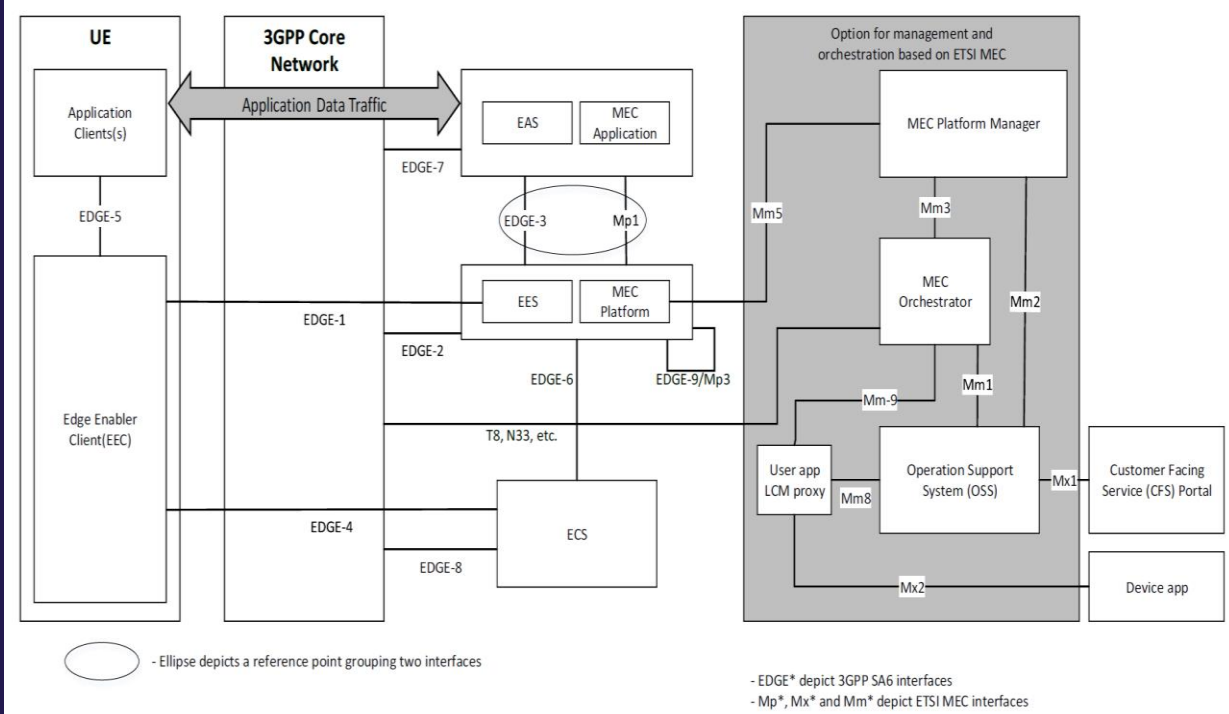

Figure 14: Relationship between ETSI ISG-MEC and 3GPP EDGEAPP architectures

General

- A first discussion in 3GPP RAN on **5G-Advanced**
 - Starting from Rel-18. Official logo is shown on the right
 - 500+ submissions from ~80 different companies/organizations
 - 1200+ checked-in participants
- Careful organization and balanced discussion of topics in three agenda items, aiming for both immediate and longer-term commercial needs
 - Three agenda items:**
 - eMBB (evolved Mobile BroadBand)-driven evolution;
 - Non-eMBB-driven evolution;
 - Cross-functionalities for both eMBB-driven and non-eMBB-driven evolution
- Some stats (very coarse!) as shown on the right → generally a **balanced evolution** in the three directions based on the submissions



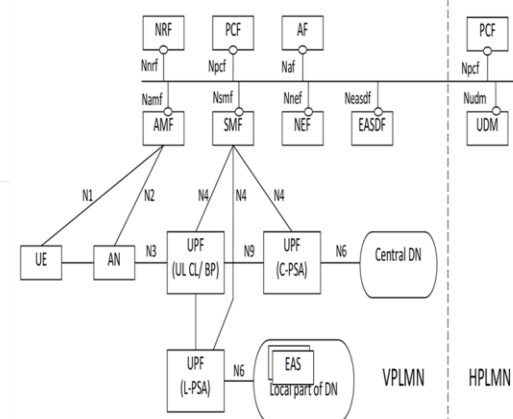



Fig.: 5G System providing access to Edge Application Server (EAS) with Data Traffic split to Local and/or Central DN scenario



ETSI MEC Update of the collaborations with OpenSource, with special focus on LF Edge Akraino

Presented by: **Jane Shen,**
VP of Technology Strategy, Mavenir
Technical Expert, ETSI MEC ISG

© ETSI 2021

15.11.2021



Enterprise Application on Lightweight 5G Telco Edge Use Case

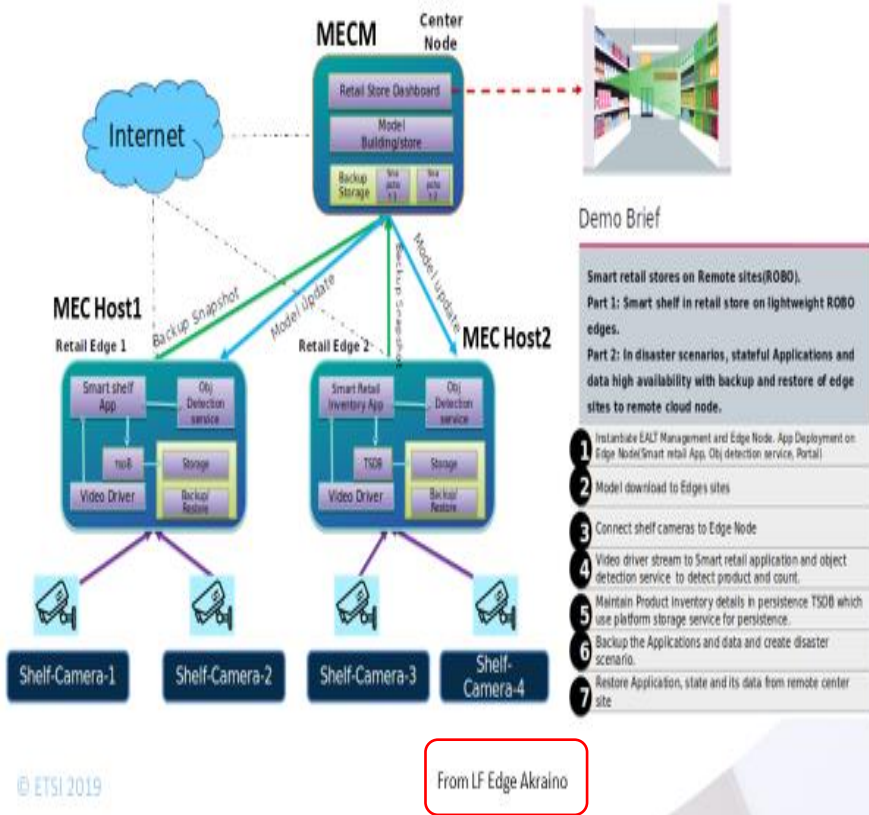

PCEI Release 5 Overview

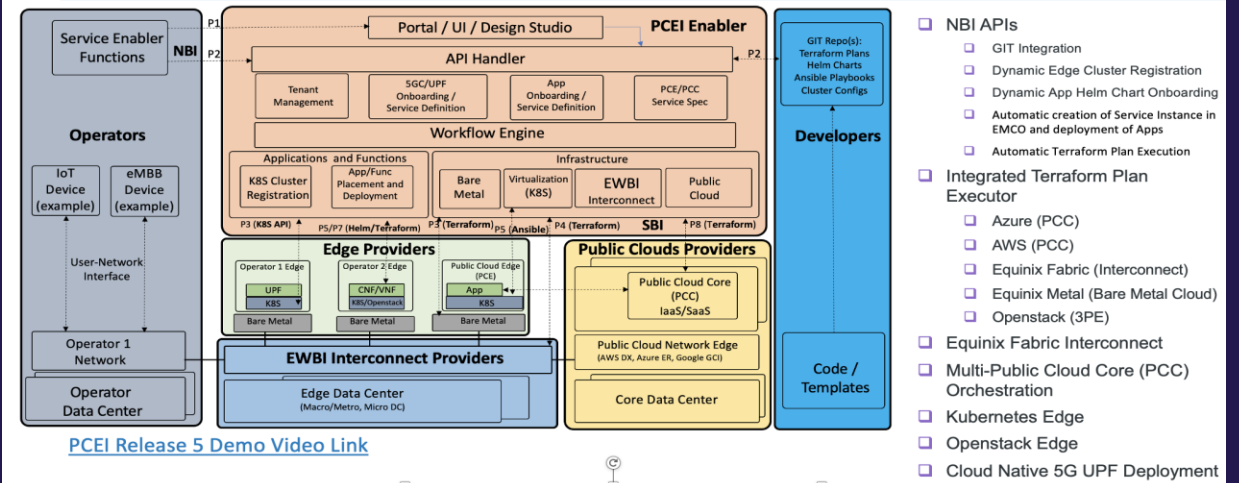

PCEI Use Case in ETSI MEC Plugtests 2021

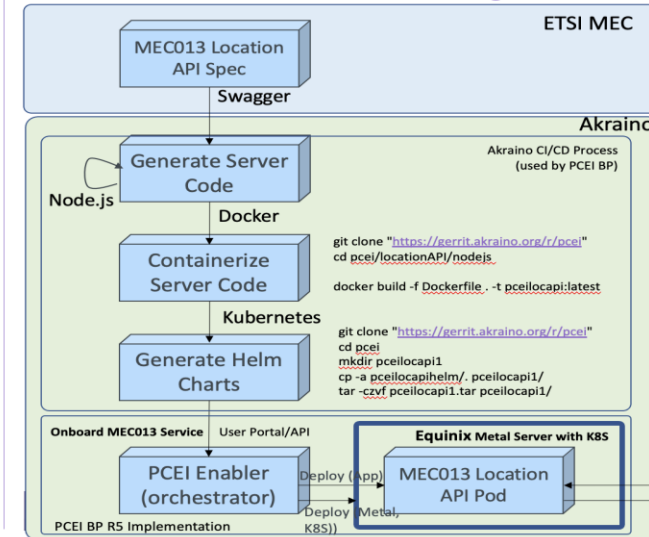

- Use ETSI MEC spec – MEC013 Location API server code
- Generate and containerize MEC013 Location API server code
- Generate Helm charts for the code to make it deployable on Kubernetes
- Use Akraino PCEI Orchestrator as a MEO/MEPM to:
 - Onboard MEC013 Location API server as a Service/App
 - Deploy Equinix Metal server (MEP/MEC Host)
 - Install Kubernetes on Metal server
 - Onboard Kubernetes cluster to PCEI Orchestrator
 - Deploy MEC013 Location API Service (as MEC App)

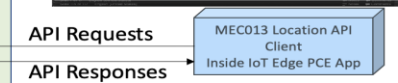



An API Portal For Edge Developers

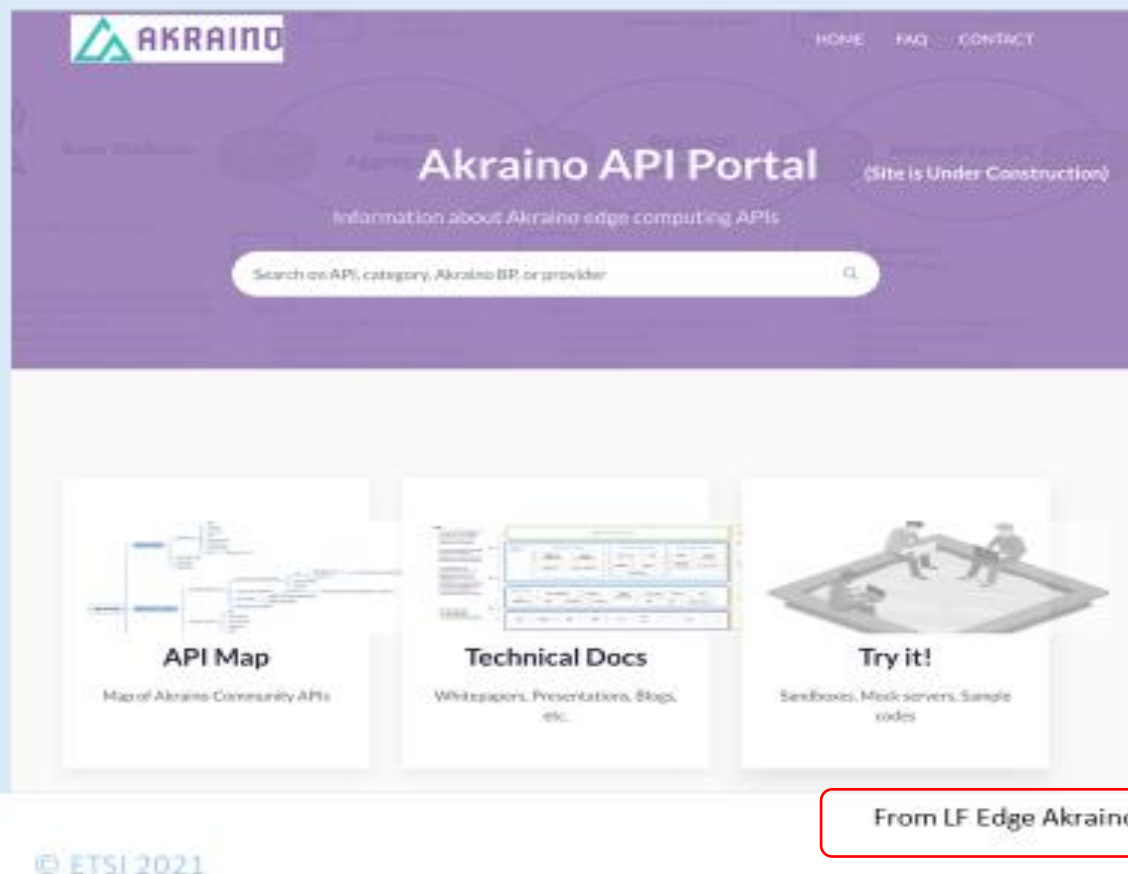

- An API info hub of Akraino projects
- Cross reference with other relevant API information sites, e.g. ETSI MEC wiki, forge.etsi.org etc.
- Highlight API offerings from Akraino projects

<https://apiportal.Akraino.org>





An API Map For Akraino Project APIs

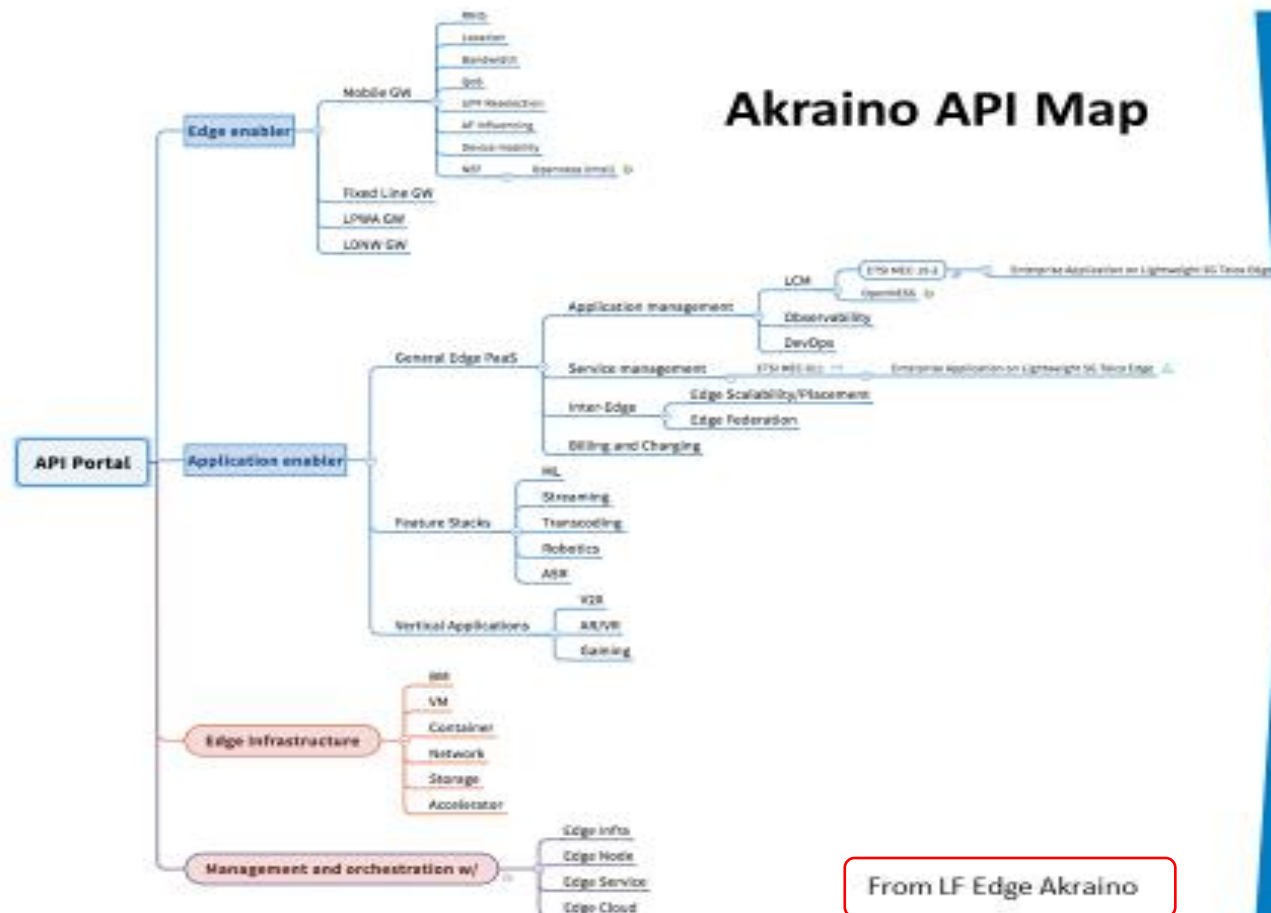

ETSI MEC DECODE

Summarized by Walter Featherstone

Group Spec (GS)	GS Version	Service Name	apiName
MEC-010-2	2.1.1	Application lifecycle, rules & req management (Mm1 & Mm3)	app_pkgm
	2.1.5		app_lcm
MEC-011	1.1.1	Platform Application Enablement (Mm1)	granting
	2.1.1		app_pkgm
	2.1.2		app_lcm
MEC-012	1.1.1	RNIS	granting
	2.1.1		rni
MEC-013	1.1.1	Location Service	rni
	2.1.1		location
MEC-014	1.1.1	UE Identity Service	location
	2.1.1		ui
MEC-015	1.1.1	Bandwidth Management (BWM) service	bwm
	2.1.1		bwm
	2.1.1		mts
MEC-016	1.1.1	UE App (Mm2)	mts
	2.1.1		mts
	2.2.1		dev_app
MEC-021	2.1.1	App Mobility Service (Interface)	amsi
MEC-028	2.1.1	WLAN Access Information Service	wis
MEC-029	2.1.1	Fixed Access Information Service	fa
MEC-030	2.1.1	V2X Information Service	vis
MEC-033	2.0.2	IoT API	iot





07/26/2021 - 07/27/2021 Akraino Automotive Area workshop

Skapad av Tina Tsou, senast ändrad av Kendall Perez den jul 27, 2021

Summary

- > Agenda:- Automotive Area deployers, developers sync-up
- > Dates: July26, 2021

Tuesday, 2021-jul-27

Meeting Location:

Join Zoom Meeting

5:15 pm
-
5:45 pm

Edge computing research, standardization and roll-out practices in CVIS and Automotive Networking Area

YiXue, Lei , Tencent

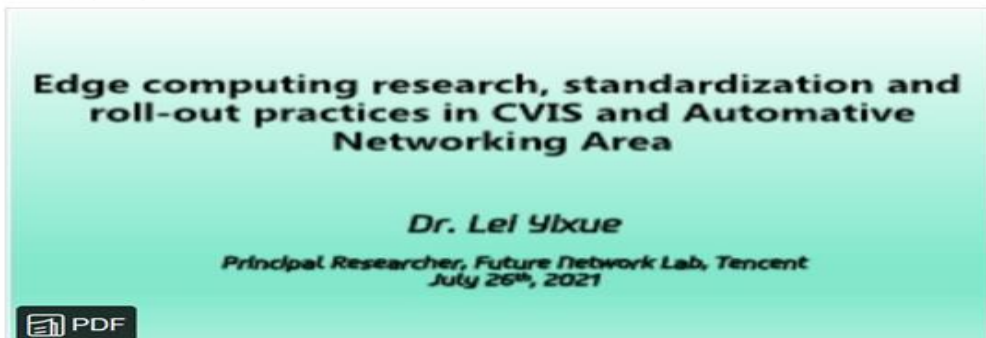

5:45 pm
-
6:15 pm

MEC-based Stable Topology Prediction for Vehicular Networks

@ Asif Mehmood



Topics

9:00 am -
9:05 am

Summary of Day 1, and Introduction of Day 2

- @ Tina Tsou , TSC Chair; @ Oleg Berzin , TSC Co-Chair

9:05 am -
9:50 am

Arm in Automotive - John Heinlein, VP North America Automotive Partnerships



9:50 am -
10:35 am

Open Discussion @ Ike Alisson





CNCF Telecom User Group meeting notes

Monday, October 4th at 15:00 UTC (8am Pacific Time)

Attendees: *Please add your name to the list below*

- Taylor Carpenter - taylor@vulk.coop - Vulk Coop
- Drew Bentley - drew@vulk.co - Vulk Coop
- Akash Manohar - akash@vulk.coop - Vulk Coop
- Lucina Stricko - lucina@vulk.coop - Vulk Coop
- Tal Liron - tliron@redhat.com - Red Hat
- Alexis de Talhouët - adetalho@redhat.com - Red Hat
- Ike Alisson - ike@alicon.se - Alicon
- Daniel Bernier - daniel.bernier@bell.ca - Bell Canada
- Chenpengxiang - chenpengxiang@chinamobile.com - China Mobile

Agenda: *Please add your agenda item(s) to the list below*

- 📌 *Please add your agenda item(s)* 📌
- [Tal - Red Hat] 20 minute presentation of [CNCK](#): Cloud Native Configurations for Kubernetes, using [Open5GS](#) as a use case example
- [Ike] - Alicon, 30min presentation on 5G Legacy of Edge and New Service Capabilities:
[Broken] <https://www.slideshare.net/secret/gyAnZIC1YpGa4V>



CNCF Telecom User Group meeting notes



5G selected Architecture Themes on 5G New Services Capabilities

to

CNCF TUG

Ike Alisson

LF Edge Akraino TSC member and Documentation

Sub-committee TSC Chair

2021-10-04

Rev PA8



- ▼ TSC Task Force: ONAP for Enterprise Business
- ▼ Enterprise Task Force Meeting Minutes

- 2021 Enterprise Task Force
- **2022 Enterprise Task Force**
- Enterprise Task Force Recordings
- ONAP / MAGMA / VES Meeting Preparation
- ONAP-Magma Architecture Collection

- › TSC Task Force: Wiki 2.0
- › TSC Task Force - Cloud Native
- › Use Case Subcommittee (replaced by Require
- › x-Deprecated Architecture Subcommittee ***

- › TSC Documentation
- › TSC Policies and Decision Logs
- Reacting, Responding and Healing

- › Releases
- › Architecture
- › Developing ONAP
- › Documenting ONAP Development
- › Setting Up ONAP

Meeting Minutes - 2022-jan-19 @7:30 am PST



- @Ike Alisson **5G Slicing enhancements related to 3GPP "5G Advanced" Specifications**
- Currently Magma is not offering the capabilities enabling us for QoS
- Importance for Magma to adopt VES Specifications supported by 3GPP - Call scheduled within the coming days

Docs » DCAE Deployment (Installation) » DCAE MS Deployment » VNF Event Streaming (VES) Collector

VNF Event Streaming (VES) Collector

Virtual Event Streaming (VES) Collector (formerly known as Standard Event Collector/Common Event Collector) is RESTful collector for processing JSON messages into DCAE. The collector supports individual events or eventbatch posted to collector end-point(s) and post them to interface/bus for other application to subscribe. The collector verifies the source (when authentication is enabled) and validates the events against VES schema before distributing to DMAAP MR topics for downstream system to subscribe. The VESCollector also supports configurable event transformation function and event distribution to DMAAP MR topics.

VES Collector (HTTP) overview and functions

- VES Architecture
- Configuration
- Delivery
- VES Collector Cloudify Installation
- VES Collector Helm Installation
- Authentication Types
- StdDefined Events Collection Mechanism

VES Architecture

VES Processing Flow
VES Schema Validation
Features Supported
Dynamic configuration fed into Collector via DCAE Platform

VES Collector in DCAE Architecture

Collector publishes based on domain; each domain assigned a unique topic
Collector support capability of multiplexing the output for resiliency

Annex B (Informative): Guidelines for the integration of 3GPP MnS notifications with ONAP VES

In case the consumer of the 3GPP MnS notifications specified in the present document is an ONAP VES collector, the following guidelines are for the developer of the corresponding notification producer:

- The produced notification conforms to ONAP-defined VES specification;
- The VES Common Event Header fields are populated by the producer as follows:
 - The domain "stdDefined" is used,
 - The "stdDefinedNamespace" field value is the concatenation of "3GPP-" and the name of the 3GPP MnS which the 3GPP IS notification is part of. Based on the MnS names defined in the present version of this document, VES name space values corresponding to 3GPP MnS could be:
 - "3GPP-Provisioning",
 - "3GPP-FaultSupervision",
 - "3GPP-PerformanceAssurance",
 - "3GPP-Heartbeat",
 - "3GPP-DataStreamingReporting",
 - "3GPP-DataFileReporting".
 - How the other fields of the Common Event Header are populated is not in the scope of the present document;
- The payload part of the VES event specification conforms to the OpenAPI definitions of clause A.1.1 (for provisioning MnS notifications), A.2.1 (for the fault supervision MnS notifications), A.4.2 (for the performance assurance MnS notifications), A.5.1 (for the heartbeat notifications) and A.7.2 (for the file data reporting MnS notifications) of the present document. The OpenAPI definitions of Annex A in the present document may also be found on 3GPP FORGE (see [46]).

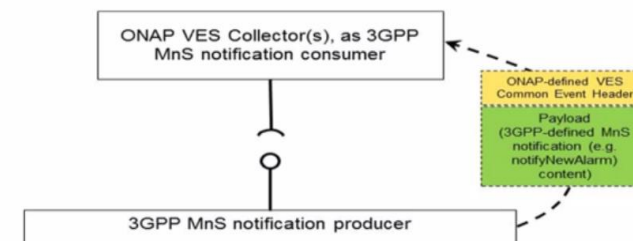

Figure X-1. 3GPP MnS notifications consumed by ONAP VES Collector(s).

<https://docs.onap.org/projects/onap-dcae-gen2/en/latest/sections/services/ves-http/index.html>

254

- @Amar Kapadia Latest update Magma/ONAP (Service Delivery):

4.2.2 Architecture

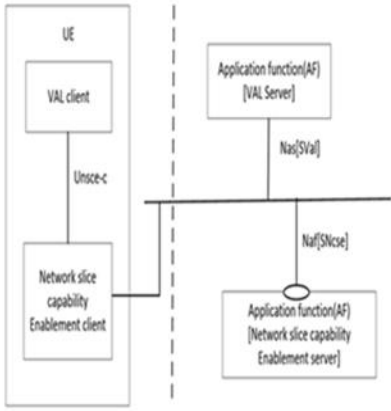

Figure 4.2.2-1 Architecture for network slice capability enablement – Service based representation

Figure 4.2.2-1 exhibits the service-based interfaces for providing and consuming network slice capability enablement services.

The mechanisms for service discovery in the service-based representation depicted in figure 4.2.2-1 are as follows:

- The network slice capability enablement server could provide service to VAL server and NSCE client through interface SNsee.

NOTE: the NSCE layer is the enhancement of SEAL NSCM layer, but which term is going to be used in the specification is FFS.

Figure 5.2.4-1 shows on which frequency each UE camps after movement.



Figure 5.2.3-1 Transition

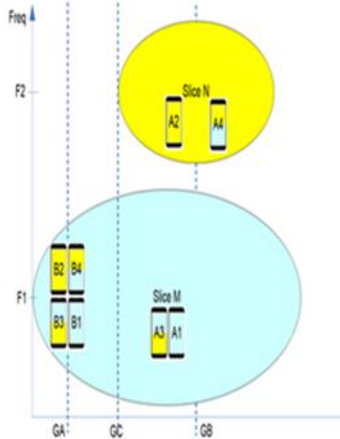

Figure 5.2.4-1 UE status after movement

5.1.2 Pre-conditions

Figure 5.1.2-1 shows the use case scenario where different network slices are configured on different frequency bands at a certain geographical location. In this scenario, all network slices and radio frequency bands belong to the same operator.

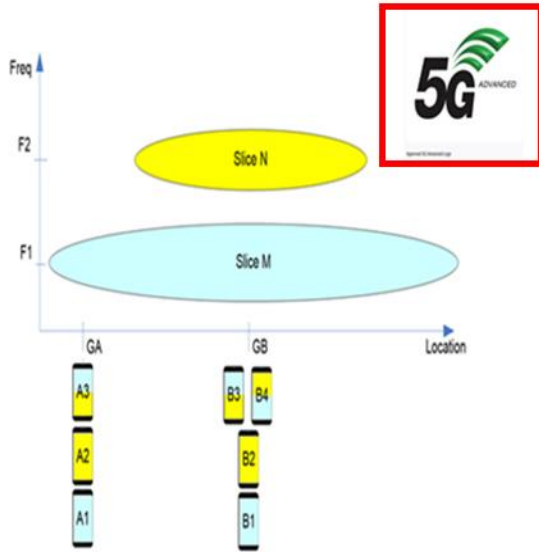

Figure 5.1.2-1 Initial Setup before-power on

5.4.4 Post-conditions

The following figure 5.4.4-1 shows the status at the end of the service flow. For the transport of user traffic, UE A1 is served by E-UTRA, UE A2 and A3 are served by NR. UE A4 may camp on either E-UTRA or NR during Idle mode and be configured with E-UTRA, NR or both depending on the active application during Connected mode.

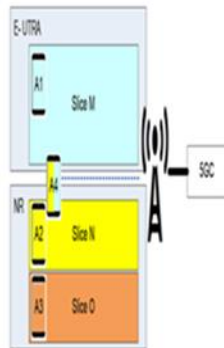

Figure 5.4.4-1 End result

Table 5.15.2.2-1: 5G Standardized Slice/Service Type (SST) Values

Slice/Service type	SST value	Characteristics
eMBB	1	Slice suitable for the handling of 5G enhanced Mobile Broadband.
URLLC	2	Slice suitable for the handling of ultra-reliable low latency communications.
MIoTT	3	Slice suitable for the handling of massive IoT.
V2X	4	Slice suitable for the handling of V2X services.
HMTC	5	Slice suitable for the handling of High-Performance Machine-Type Communications.

Attribute		Value
Availability		99.999
Device Velocity		0
UE density (per km ²)		1000
Mission critical support		Mission critical
	Mission-critical capability support	Inter-user prioritization
	Mission-critical service support	MCDATA
Slice quality of service	3GPP 5QI	83

Table 72 List of attributes needed for NEST for HMTC SST

Attribute		Value
Availability		99,9
Slice quality of service	3GPP 5QI	9
Supported device velocity		2
UE density		100000

Table 71 List of attributes needed for NEST for MIoT SST



09/15/2021 Akraino IoT Area Webinar / Regional Developer Meetup - Africa

Skapad av Tina Tsou, senast ändrad av Stephen Ozoigbo den sep 15, 2021

The Linux Foundation Akraino community will conduct a workshop on Wednesday, September 15 (Local time, GMT+2) online.

Registration Link: https://zoom.us/meeting/register/tJtceGvqDouGd1ToS3OyzaVb_Sb16eDDPZz

On September 15, 2021 (9.00am -2.00PM PST) the Akraino community will participate in a partner event online.

Launched in 2018, and now part of the LF Edge umbrella, Akraino is creating an open-source software stack that supports a high-availability cloud stack optimized for edge computing systems and applications. Designed to improve the state of edge cloud infrastructure for enterprise edge, OTT edge, and carrier edge networks, it offers users new levels of flexibility to scale edge cloud services quickly, to maximize the applications and functions supported at the edge, and to help ensure the reliability of systems that must be up at all times. The Akraino Edge Stack blueprints use several upstream open-source projects such as ORAN Alliance, CNCF, Openstack, ONF, ONAP, TIP and the community works with open-source communities to enhance any missing edge functionality.

This workshop will provide an overview of leading use cases of Edge computing systems and applications in Africa with a focus on V2X, IoT and Enterprise Edge solutions.

With key presentations from leading African infrastructure stakeholders, this workshop will provide a unique opportunity to gain unique insights on current infrastructure solutions across the African continent as well as specific technology approaches for the fastest growing industry verticals. In addition to providing detailed coverage of topics related to the current state of Edge computing on the African continent, there will be an opportunity for peer networking to connect with fellow professionals and expert industry practitioners.

There is no cost to attend the event and we encourage everyone interested in edge computing infrastructure and related opportunities in Africa to attend.

Agenda:

Workshop, Wednesday, 2021-sep-15 9.00am - 2.00 p.m PST

Location: Zoom link will be emailed to you after you register

Registration Link: https://zoom.us/meeting/register/tJtceGvqDouGd1ToS3OyzaVb_Sb16eDDPZz

IoT Opportunities in Africa:
 Webinar and Regional Developer Meetup
 September 15, 2021
 09.30 - 13.30 PST
 Registration - <https://bit.ly/AfricaloT>





11/24/2021 Akraino presentation to KICS on IoT (Korean Institute of Communications and Information Sciences)

Skapad av Ike Alisson, senast ändrad den dec 30, 2021

Akraino presentation to KICS on IoT (Korean Institute of Communications and Information Sciences) about update on Open Source and Standard trends related to 3GPP 5G and oneM2M IoT SL (Service Layer) Global Standard evolvement.

KICS is the largest ICT Institute in Korea with over 26,000 members, 50 members, 8 domestic and 5 overseas chapters, and 30 specialized Research Groups. As the growth engine and leader of ICT in Korea that has achieved the greatest accomplishments in the world, KICS provides open networks for Universities, Corporations, Government-affiliated Agencies and Research Institutes to engage in Academic activities, Technical Cooperation and Policy Reviews in the fields of ICT-based Communications, Broadcasting and ICT Convergence Industries. Today, with the upcoming future driven by the Fourth (4th) Industrial Revolution, KICS is opening a new future for ICT with the pride and passion that led Korea's Information and Communications Technology that amazed the world. KICS is at the heart of the limitless competition of the Fourth (4th) Industrial Revolution. For further information about KICS, please visit the KICS web site: <https://eng.kics.or.kr/html/?pmode=intro>



<https://wiki.akraino.org/display/AK/IoT+Area>



Questions ?

