

Common NFVI Telco Taskforce

Introduction

Akraino Edge Stack

March 3, 2020

 THE **LINUX** FOUNDATION



CNTT | Problem Statement

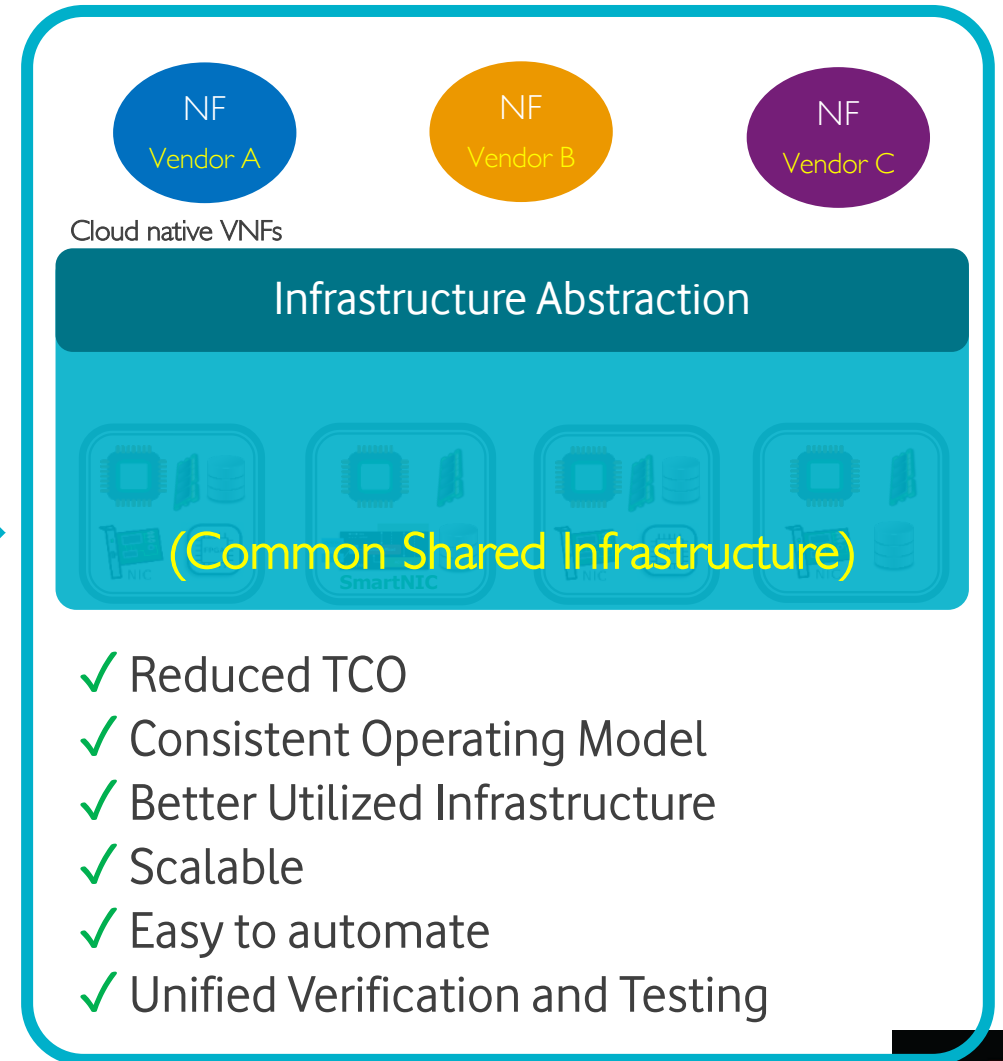
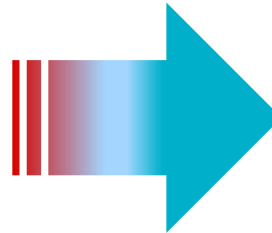
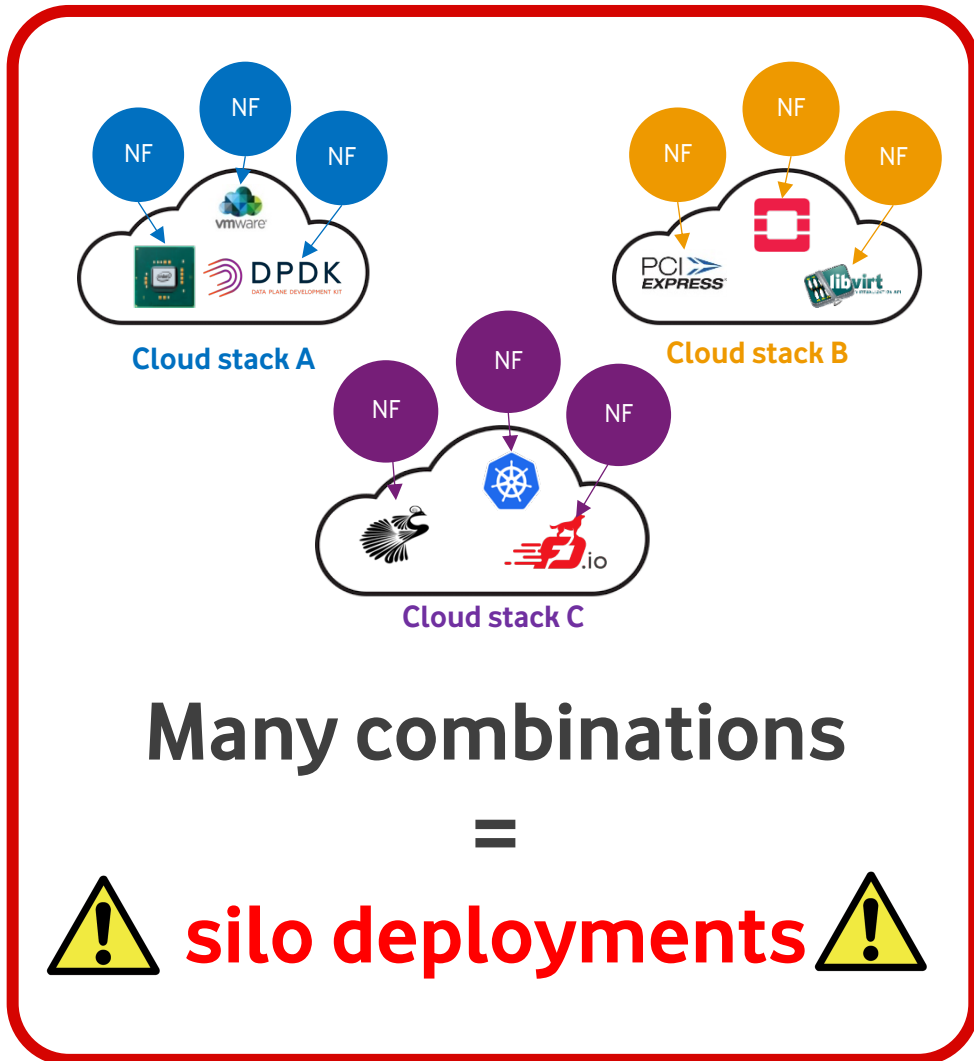

CNTT | Mission Statement

MISSION

Establish NFVI Reference Model, Architectures, & NFVI | VNF Verification Lifecycle to reduce cost, time to market, & complexity of Telco operations for the benefit of the broader community



CNTT COMMUNITY

Note: View includes observers, supporters, & contributors



CNTT | Current VNF Onboarding Model

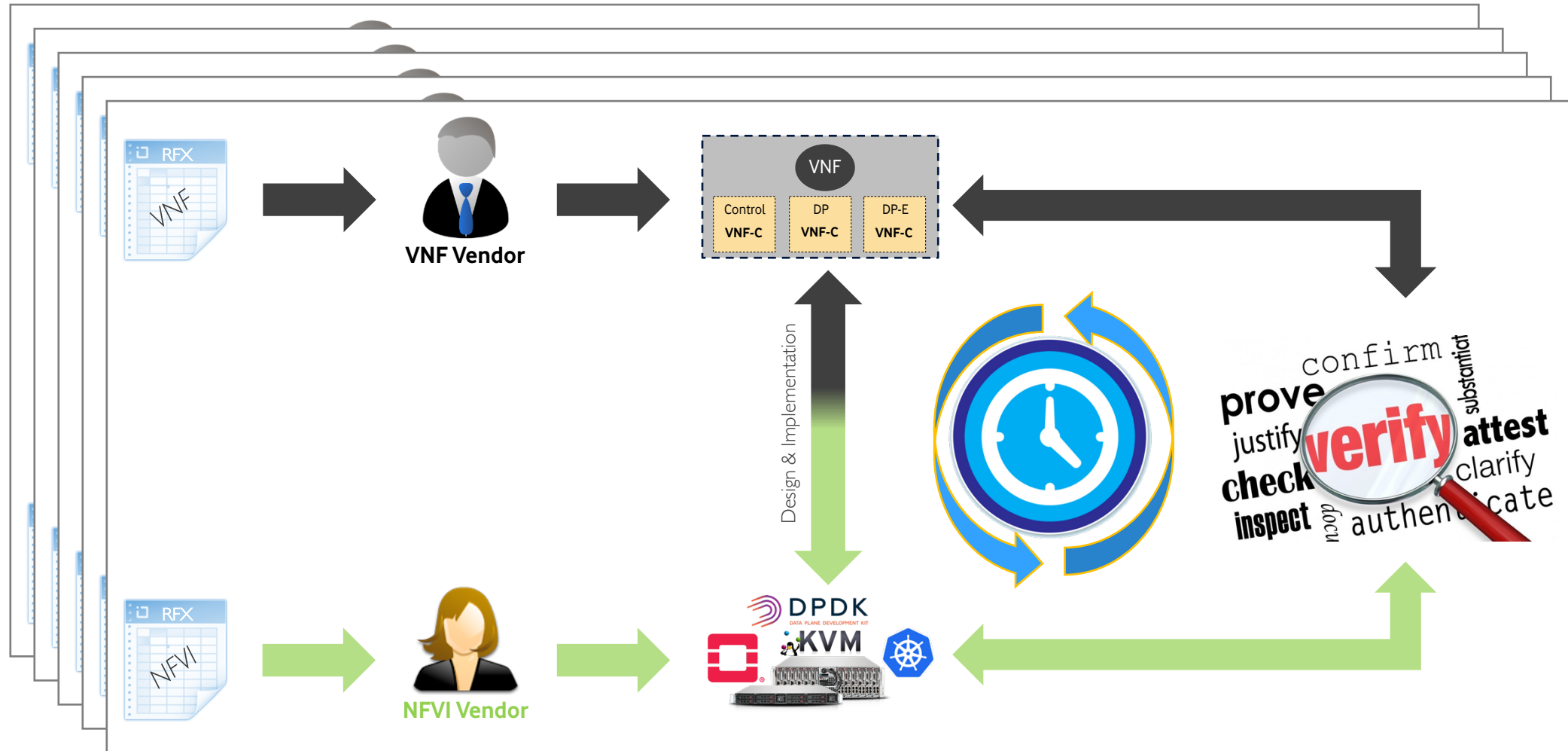

CNTT | Onboarding with CNTT

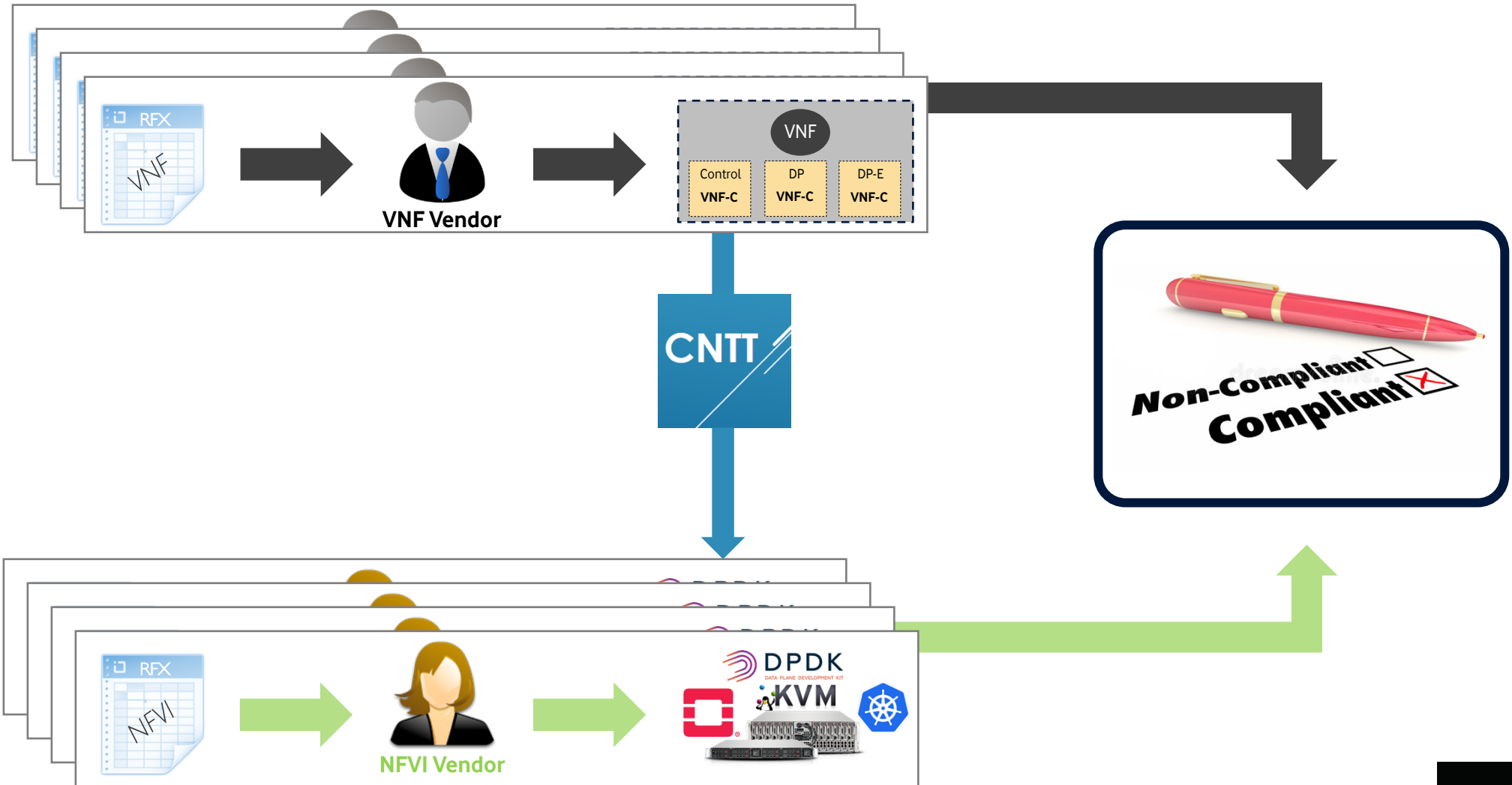

CNTT | Scope

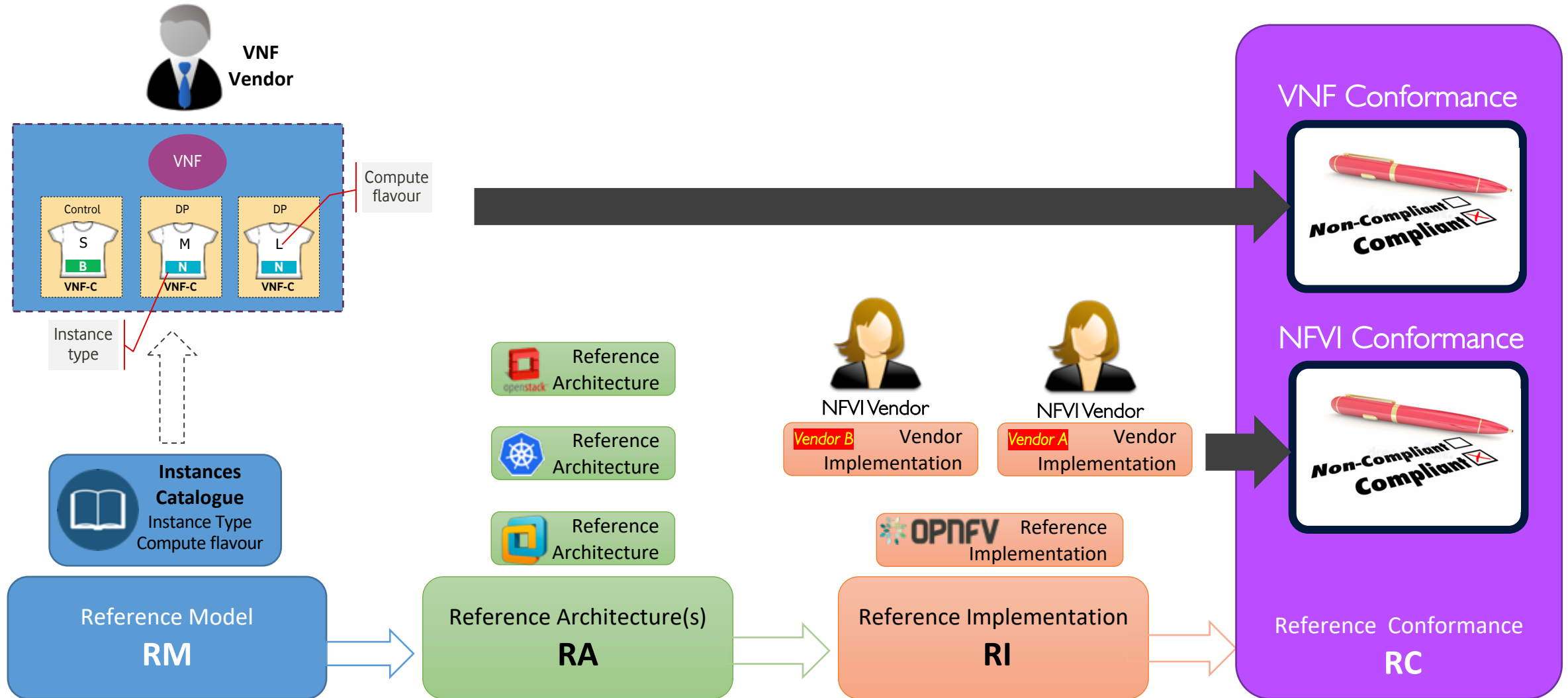

CNTT | Current and Planned Workstreams (WS)

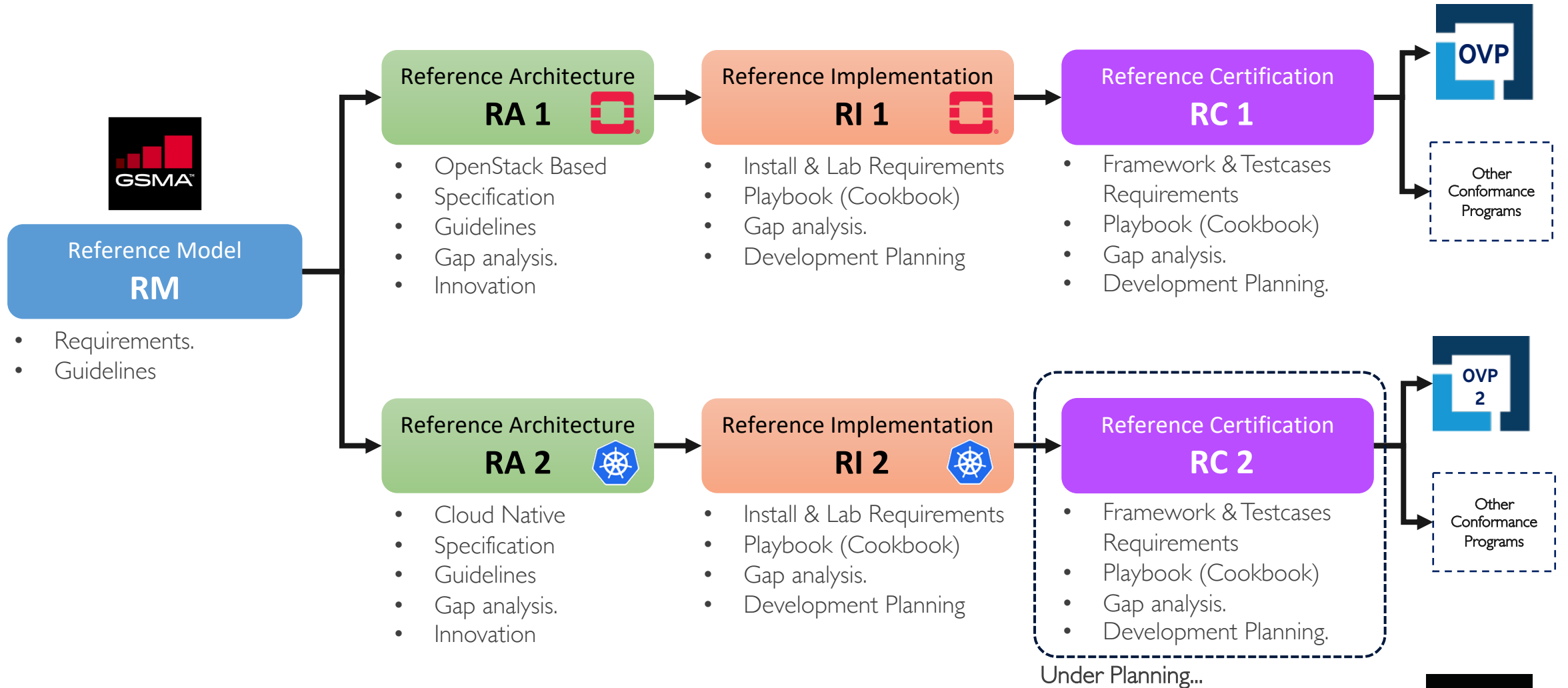

CNTT | Roadmap

 Pre-alpha releases
 alpha releases

- Reference Model
- Reference Architecture
- Reference Implementation
- Reference Certification

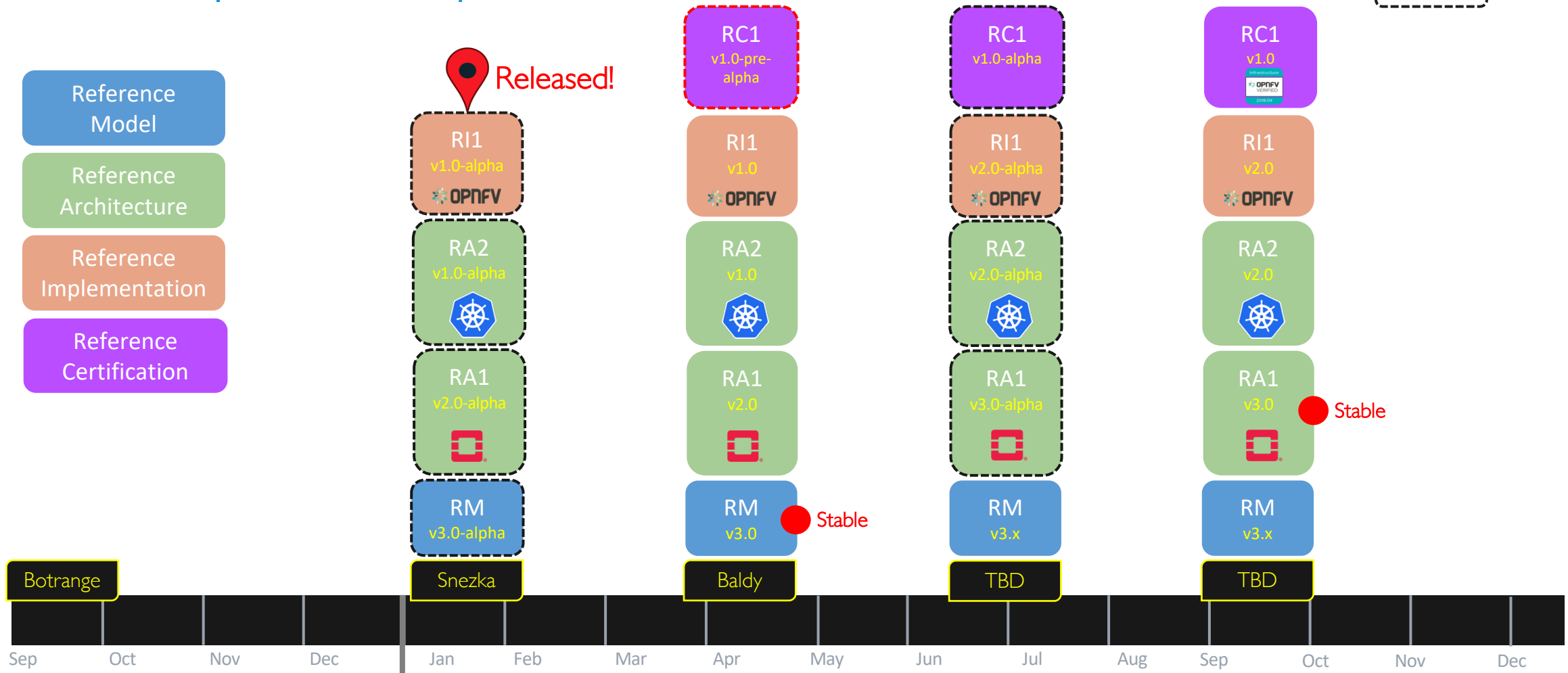

CNTT | How to Contribute



<https://github.com/cntt-n/CNTT>



<https://cntt-n.github.io/CNTT/>



<https://github.com/cntt-n/CNTT/wiki>

Reference Model

RM

https://github.com/cntt-n/CNTT/tree/master/doc/ref_model

Reference Architecture

RA

https://github.com/cntt-n/CNTT/tree/master/doc/ref_arch

Reference Implementation

RI

https://github.com/cntt-n/CNTT/tree/master/doc/ref_impl

Reference Certification

RC

https://github.com/cntt-n/CNTT/tree/master/doc/ref_cert

**GET
INVOLVED!**

Thank you 😊

 THE **LINUX** FOUNDATION

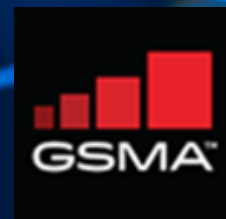

Common NFVI Telco Taskforce

Backup

 THE **LINUX** FOUNDATION



CNTT | NFVI Testing and Certification

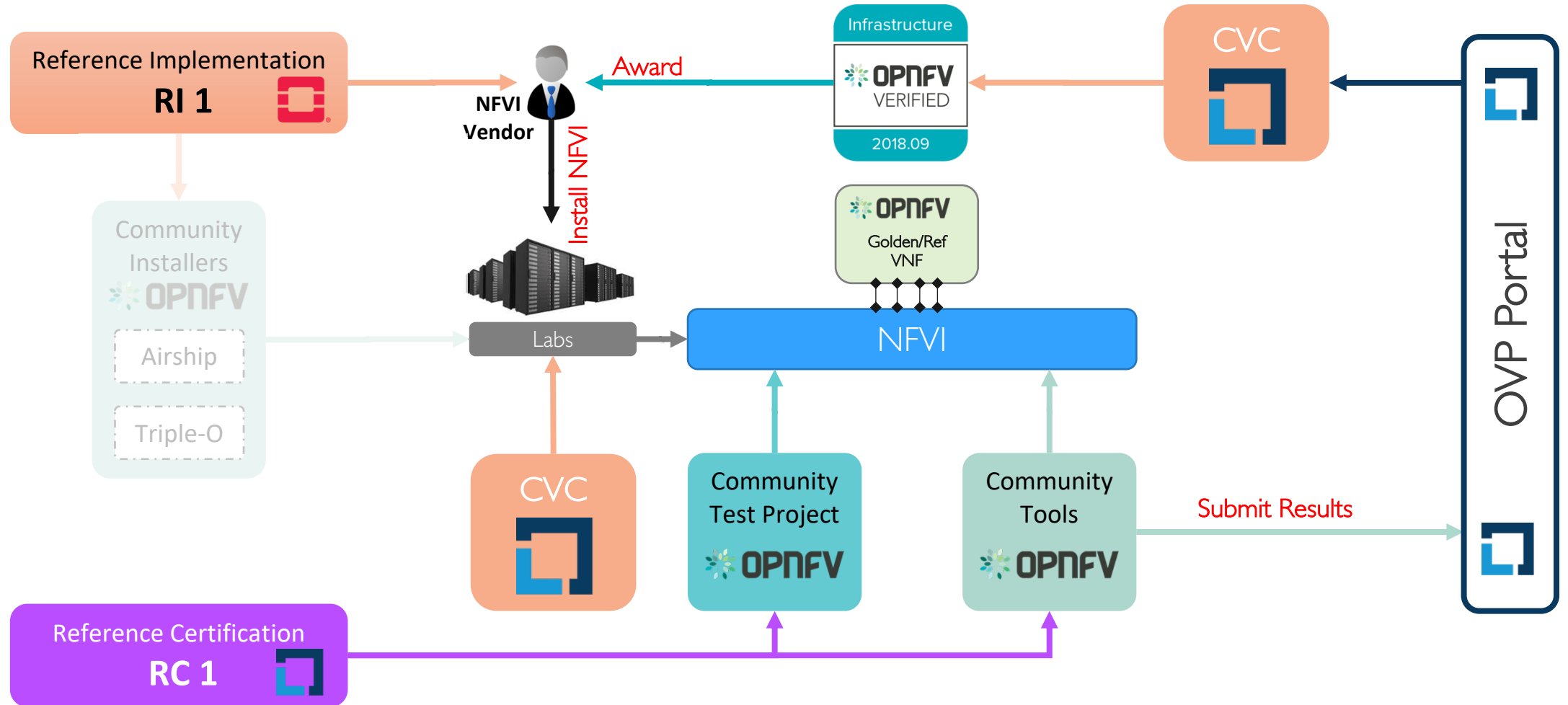

CNTT | VNF Testing and Certification

